

WHERE QUALITY  
MEETS PERFORMANCE

# CELTEC

## USER MANUAL

### HOW-TO GUIDE

No part of this publication may be reproduced, stored in a retrieval system or transmitted, in any form or by any means, mechanical, electronic, photocopying, recording, or otherwise, without prior written permission of Vycom.

Vycom  
801 E. Corey Street  
Scranton, PA 18515  
P: 570.246.8254  
F: 570.304.6542

[www.vycomplastics.com](http://www.vycomplastics.com)

Celtec is a registered trademark of Vycom.

© 2012 by Vycom  
All rights reserved.

All information contained herein is accurate to the best of our knowledge and is provided without liability or commitment whatsoever. All recommendations or suggestion are make without guarantee, since the conditions of use are beyond our control. We recommend that you confirm the suitability of our product by carrying out tests under your local conditions and using your own mechanical equipment.

We disclaim any liability incurred in connection with the use of these data or suggestions. This publication is not to be taken as a license to o operate under or a recommendation to infringe any patents. The observance of all legal regulations and patents is the responsibility of the user.

Processing and finishing techniques are presented as “typical.” Information container herein is considered accurate to the best or our knowledge. It is offered for your consideration and investigation, and is not to be construed as a representation or warranty, expressed or implied, for which Vycom assumes any legal responsibility. Our warranties are limited to those expressly stated in the written contracts or in conditions of sale. As conditions and methods of use vary and are beyond the control of Vycom, Vycom disclaims any liability incurred as a result of the use of its products in accordance with the data contained on our physical properties charts or in our manual. No information herein shall be construed as an offer of indemnity for infringement or as a recommendation to use the products in such a manner as to infringe any patent, domestics or foreign.

# Contents

CELTEC®



4	<b>Contents</b>	36	Pressure or Drape Forming
5	<b>Introduction</b>	38	Vacuum Forming
7	<b>Product Availability</b>	38	Heat Welding
9	<b>Chapter 1: Processing</b>	40	Manufacturers
9	Handling	43	<b>Chapter 4: Graphics Applications</b>
9	Cutting	43	Cleaning / Pretreating
10	Die Cutting	44	Digital Flatbed Printing
18	Sawing	45	Painting / Varnishing
19	Drilling	49	Specification
19	Milling	50	Vinyl Lettering
20	Routing	50	Manufacturers
20	Edge Finishing	56	Addendum
20	Laser Cutting	57	<b>Chapter 5: Special Applications</b>
20	Waterjet Cutting	57	Photo Mounting
21	Manufacturers	58	Laminating
23	<b>Chapter 2: Fastening</b>	60	Laminating Techniques
23	Notch Sensitivity	66	Manufacturers
23	Thermal Expansion/Contraction	67	<b>Chapter 6: Engineering Specifications</b>
27	Screwing and Nailing	67	Weatherability
28	Installation	68	Fire Characteristics
29	Bonding and Adhesives	69	Standard Specifications
30	Weld-On® Adhesives	71	Foam PVC Specifications
31	Adhesives and Manufacturers	73	<b>Chapter 7: Celtec Resources</b>
35	<b>Chapter 3: Forming / Welding</b>	73	Marketing Communication
35	Heat Bending	73	Material Safety Data

# Introduction



CELTEC®

Celtec® is a lightweight, expanded foam polyvinyl chloride (PVC) sheet material manufactured by Vycom that combines the chemical resistance and fabrication capabilities of rigid PVC with a closed cell expanded core.

Vycom introduced Celtec in 1987 primarily for the graphics market. Today our increased capacity allows us to manufacture Celtec in gauges from 1mm through 30mm for use in an expanding variety of markets. The structure of Celtec is a closed cell foam that does not absorb moisture. These features combined with its light weights and insulating characteristics (sound and thermal) make Celtec the choice material for exterior and harsh moisture environments.

Celtec has a high quality surface for both screen and direct Digital Printing using the flatbed feed technology, as well as painting and applying vinyl graphics. It is lightweight for easy handling. It has low flammability and good chemical resistance to meet or exceed industry standards for a wide variety of applications, including exhibits, displays, signs and theater props. Celtec applications are limited only by your imagination. We are always eager to learn about new and exciting applications. **Please contact our Marketing Department if you discover a creative new use of Celtec.** <http://www.vycomplastics.com/contact.php>

The inherent properties of Celtec eliminate time-consuming and costly surface preparation. In addition, the material can easily be cut, joined and fabricated with a wide variety adhesives and ordinary fasteners and using readily available hand tools. Celtec can be milled and routed like wood and often more quickly. Because there are no knots, there is little likelihood of voids or holes in the mid-wall. Celtec is free foam and therefore does not have the inherent problems of voids that the Celuka process does. Celtec has a very small cell structure enabling superior edge finishing and routing. By varying the feed rates and speeds, you can attain a very smooth edge. When an even smoother edge is necessary, sanding and planing can be performed, as can laminating edge finishing.

Celtec also offers superior thermal properties and low thermal conductivity as well as high insulation and sound absorption qualities. See the Engineering Specifications section of this manual for detailed information.

As a rigid and lightweight foamed PVC sheet, Celtec is excellent for the highly specialized needs of producing signage and displays as well as booths and stage sets. Other applications include photo mounting and building materials. Celtec is USDA approved for incidental contact “wherever food is processed or sold.” Celtec is free of lead, barium and cadmium. And as the first foamed PVC to be U.L. Classified, Celtec meets all three U.L. 1975 fire test requirements, minimizing the risk of both head conduction and fire.









Vycom, headquartered in Scranton, Pennsylvania, is a world leader in the production of thermal plastic sheet products, and is dedicated to growth through investing in state-of-the-art processing equipment, developing rigid quality control standards, creating new material formulations, and expanding the physical plant to provide the scope and quantities of materials required by customers' rapidly growing demands. Along with its subsidiary companies, Vycom's physical plant occupies over 1.3 million square feet of production, storage and office space. The plant's annual production capacity is in excess of 300 million pounds.

# Product Availability

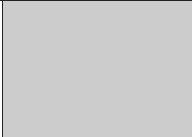
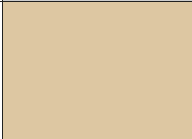

CELTEC®

Custom colors, sizes, gauges, tolerances and formulations are available upon request and with a minimum order. Actual color may vary from production run to production run. Because of limitations in printing, precise color may be different from samples shown below.

<b>NOTE!</b>		PMS numbers are an approximation to provide designers with a color range. Actual color may be different from printed samples shown below.				
<b>Color</b>	<b>Sample</b>	<b>PMS</b>	<b>RGB</b>	<b>CMYK</b>		<b>HEX #</b>
White		0	R: 255 G: 255 B: 255	C: 0 M: 0	Y: 0 K: 0	#FFFFFF
Black		Black	R: 0 G: 0 B: 0	C: 0 M: 0	Y: 0 K: 100	#000000
Gray		Gray 8C	R: 140 G: 140 B: 140	C: 0 M: 0	Y: 0 K: 45	#8C8C8C
Stone		Cool Gray 4	R: 204 G: 204 B: 198	C: 0 M: 0	Y: 3 K: 20	#CCCCCC
Beige		Beige 400	R: 208 G: 193 B: 164	C: 18 M: 19	Y: 27 K: 0	#D0C1A4
Yellow		Yellow 123	R: 252 G: 198 B: 16	C: 1 M: 22	Y: 95 K: 0	#FCC610
Green		Green 355	R: 39 G: 154 B: 55	C: 85 M: 0	Y: 95 K: 0	#1D9A37
Red		Red 703	R: 192 G: 0 B: 15	C: 0 M: 100	Y: 85 K: 24	#C0000F
Blue		Blue 653	R: 17 G: 22 B: 134	C: 100 M: 87	Y: 0 K: 0	#111686

Color	Available Thickness (metric) / Sheet Sizes (inches) - Standard Sizes (as of July 2012; subject to change)											
	1mm	2mm	3mm	4mm	5mm	6mm	10mm	12mm	15mm	19mm	25mm	30mm
White	49 x 97	48 x 96 48 x 120 60 x 120	38 $\frac{1}{8}$ x 87 48 x 96* 48 x 120 50 x 100 60 x 96 60 x 120	48 x 96	48 x 96	48 x 96* 49 x 120 60 x 96 60 x 120	60 x 120	48 x 96 48 x 120 60 x 120	48 x 96 48 x 120 60 x 120	48 x 96 48 x 120 60 x 120	48 x 96	48 x 96
Black	49 x 97	48 x 96	48 x 96* 49 x 120 60 x 96 60 x 120		48 x 96	48 x 96* 49 x 120 60 x 96 60 x 120	48 x 120	48 x 96 48 x 120 60 x 120		48 x 96 48 x 120	48 x 96 48 x 120	
Gray			48 x 96			48 x 96	48 x 96	48 x 96				
Stone			48 x 96			48 x 96						
Beige			48 x 96			48 x 96						
Yellow			48 x 96			48 x 96						
Green			48 x 96			48 x 96						
Red			48 x 96			48 x 96						
Blue			48 x 96			48 x 96						
Ultra White		48 x 96*	48 x 96*			48 x 96*						

\* Size / color available masked, one side.



This chapter details various methods of fabricating Celtec as part of processing the material into its final form. Common metal and woodworking tools and machinery can be used, depending on the specific application for the finished product.

## Handling

Celtec material should be ordered in bulk and remain untouched. Celtec material should be properly stored in a clean, cool, dust free, controlled environment.

All Celtec material, if cleaning is necessary, should be cleaned the same way using alcohol, either with isopropyl or denatured, and wiped thoroughly in one direction.

Human hands contain oils and acids that alter the print characteristics of a substrate. Oils will alter the print surface by lowering the surface tension / dyne level, which result inflaws on print that resemble lighter ink areas in the shape of finger prints. Acids will etch into the materials and over time, will cause a tiny recess in the material surface as the acid eats part of the substrate away. Recent fingerprints can be easily wiped off with alcohol, either with isopropyl or denatured, and wiped thoroughly in one direction. Older finger prints cannot be wiped off because of the physical and chemical changes it has caused on surface of the substrate. All personnel (manufacturer, dealer, shipper, material handler, etc.) that handles the substrate prior to printing should wear clean cotton gloves.



## Cutting

Sheets of Celtec up to 3mm thick can be cut with a utility knife. To cut sheets thicker than 3mm, band saws, table saws and panel saws can be used, as detailed later in this chapter. Power sheers and guillotines can crush the edges of Celtec sheets over 4mm and generally produce unacceptable results.

With any cutting procedure, friction heat can build up and produce unacceptable results on cut edges. Rough edges can also occur from cutting the Celtec using inadequate support or from using worn or improper tooling. For best results, test the machine setups and cutting processes before beginning production.

<b>NOTE!</b>	Celtec’s density is approximately half the density of conventional PVC, which makes it compress relatively easily.
--------------	--

## Die Cutting

When Celtec sheets are used for mass producing flat shapes or cutouts, die cutting is the most commonly used fabrication technique. Celtec is an ideal material for die cutting, producing a clean, smooth edge without splintering or cracking. Die cutting is recommended for a wide range of applications, including letters, openings within larger sheets of Celtec, puzzle pieces and assemblies that fold into three-dimensional shapes, such as point-of-purchase (POP) displays (Figure 1a).

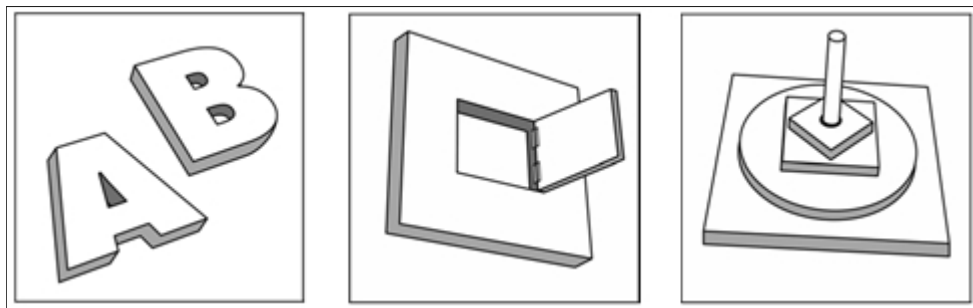

Figure 1a

To improve processing efficiency, Celtec sheets can be painted, printed or silkscreened prior to die cutting. After die cutting, the Celtec sheets or pieces can be finished by heat bending, fastening, gluing or machining.

<b>NOTE!</b>	Test the die cut suitability of the Celtec material before painting or silk-screening an entire production run. Select proper inks and paints for die cutting.
--------------	--

# Processing

Of the various die cutting methods available, the most frequently used method is Steel Rule Die Cutting, in which the steel rule die (SRD) functions very much like a cookie cutter.

SRD's are constructed from one-inch wide strip steel, available in 500-foot coils, with one pre-sharpened edge. The thickness of the strip steel can be specified by a **point** designation, with one point equaling 0.014" inches. To cut Celtec with an SRD, the recommended thickness of strip steel ranges from 2 points (0.028" inches) to 6 points (0.084" inches). The most commonly used strip steel thicknesses for cutting Celtec are 3 points (0.042" inches) and 4 points (0.054" inches).

To construct the die, lengths of strip steel are first cut from the coil. These cut lengths called **knives**, are then bend to the desired shape or pattern to be cut and embedded in a maple block called a **die body**.

The SRD assembly is mounted under the top platen of the press. The Celtec sheet is then placed on a steel bottom platen. When pressure is applied, the knives of the SRD forced through the Celtec, producing a **cut**.

Hydraulic platens or "clicker" presses are used to supply the necessary pressure for the cut. After the cut, the platens are separated, and the sheet or cutouts are removed. At this point, any finished work required can begin.

To help eject the cut Celtec, strips of a resilient, compressible material, such as open cell foam rubber, can be glued next to the knives (Figure 1b). The strips should extend about 1/16" inch beyond the cutting edge of the knife. Strips of the same material can be used to secure the sheet in position by gluing the strips to the top or bottom platen of the press.

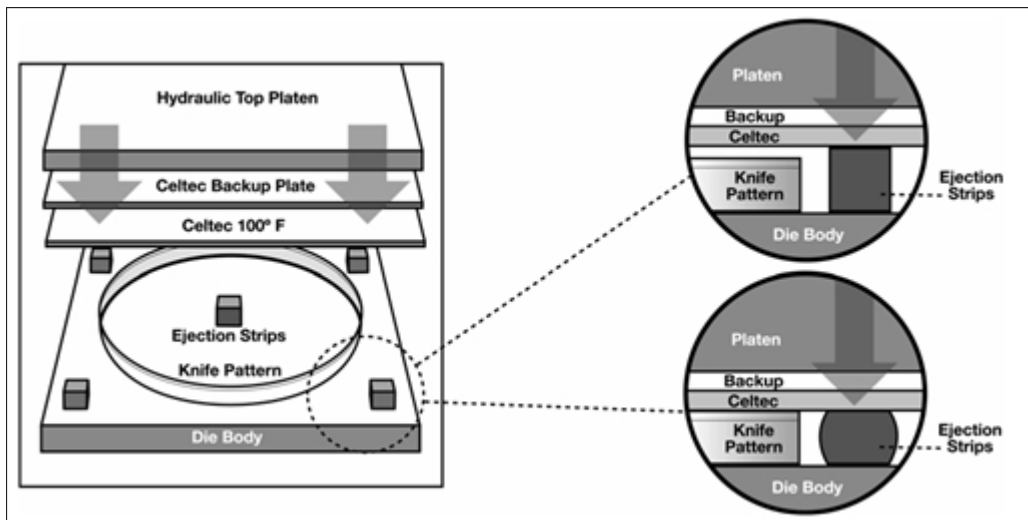

Figure 1b

**NOTE!** For best results, dull or worn knives should be replaced as needed with new ones.

#### Factors affecting die cutting quality.

**Temperature of the Celtec material.** Celtec is a thermoplastic, which has a tendency to be more brittle at lower temperatures. When the Celtec sheet temperature is below 75°F, the first two-thirds of the cut is clean, while the last third exhibits fracturing. When the Celtec material is heated above 75°F, the quality of the cut improves, and fracturing is reduced. The best result is achieved when Celtec is preheated to 100°F.

#### TIP

For complex die cut parts, a higher temperature during cutting will reduce the likelihood that fracturing of the Celtec will occur.

**Sheet Thickness.** The quality of the die cut is also affected by the material's thickness. The best cuts are produced using Celtec sheets of 3mm or less. Die cuts in Celtec sheets over 4mm tend to exhibit deformation, roughness along the cut edge and / or fractures in the material. To cut Celtec:

1. Verify that the SRD has the proper point value and bevel.
2. Preheat the material to 100°F.
3. Select the appropriate backup plate.
4. Maintain a sharp cutting edge.

For material over 4mm thick, additional steps, such as sanding or routing, may be necessary after die cutting to smooth any rough edges produced by the cut.

The thickness of the Celtec material will also affect the quality of the die cut when the piece has one or more small radii. As the thickness increases, the difficulty involved in producing smooth cuts with small radii also increases. Sheets 4mm thick or less can be die cut using a radius as small as 1/8" inch.

# Processing

CELTEC®



**Knife Thickness.** As the knife edge penetrates the Celtec, it exerts an enormous compressive force, which can produce deformation, or rounding, of the material's corners. The knife's penetration also creates a shearing force which tends to cause fracturing of the material approximately two-thirds of the way through the Celtec sheet. Applications that require cutting of narrow radii or U-shaped tabs are highly susceptible to shearing because of the severe lateral pressure.

The selection of a correct **gauge** (point thickness) for the knife material is critical for any die cutting operation. For example, straighter, smoother cuts involving small radii are more readily achieved using a thinner rather than thicker gauge knife steel, assuming that both knives have the same bevel configuration and angle. However, a thinner knife is more vulnerable to warping, bending or breaking because of the extreme compression when the Celtec is thick, especially when the sheet is below 100°F.

## TIP

A thinner gauge knife will not require as high a sheet temperature to produce equivalent quality die cuts because a thinner knife encounters less resistance and creates a cleaner edge on the cut Celtec. A thicker knife will require that the Celtec be heated to make it more flexible and less brittle in order to create a similar die cut quality.

The appropriate die knife thickness is directly related to the thickness of the Celtec material being cut. If the knife is too thin for the thickness of the Celtec, the knife is prone to breaking. If it is too thick, the knife tends to deform the Celtec material.

When die cutting Celtec sheets, use the following guidelines to determine the appropriate knife size.

- For most common applications, a 3-point or 4-point (0.042" or 0.056") knife is recommended.
- For cutting complex parts in sheet material less than 4mm, a 2-point (0.028") knife is recommended.
- For sheets over 6mm or for wide separating cuts, a 6-point (0.084") knife is recommended.

**Correct bevel selection.** Knife bevels vary according to length and type. Bevel length is defined as the distance from the tip to the end of the honed surface. When cutting Celtec, the length of the bevel should be between 3/16" and 1/4" inches (Figure 1c).

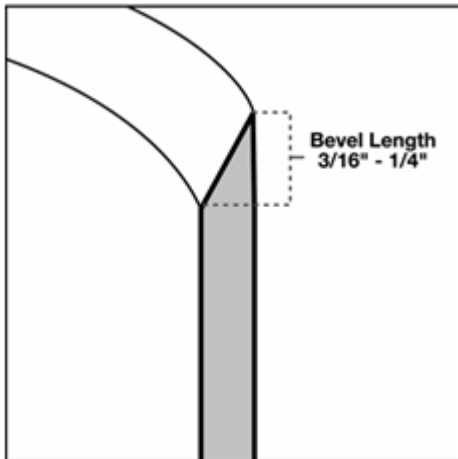

Figure 1c

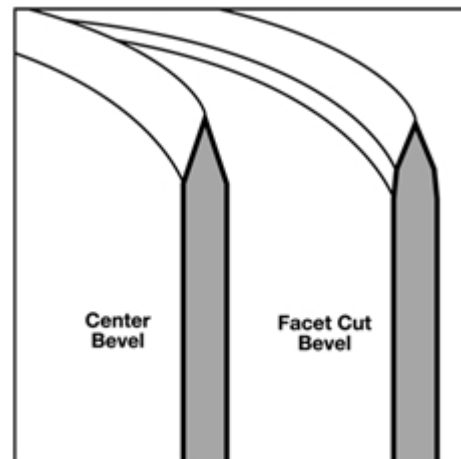

Figure 1d

The bevel can be one of three basic types: center, inside or outside. A **center bevel** is honed from both sides, producing a V-shaped point with each leg of the V being equal. A modified center bevel, or **facet cut bevel**, is recommended for cutting Celtec. To create a facet cut bevel, the V of a center is honed for a second time, giving the lead cutting edge a more obtuse angle (Figure 1d).

**TIP**

In general, the longer the length of the bevel, the smoother the resulting cut.

With either a center bevel or a facet cut bevel, the longer the bevel length and the thinner the knife, the more vertical the perimeter cut.

**TIP**

When both the inside and outside parts of a cut must be used, such as with jigsaw puzzle pieces, a center bevel is suggested because the resulting cut is wedge-shaped, thus giving both the inside and outside pieces an individual, sloped cut.

# Processing

CELTEC®



CELTEC  
GRAPHIC & DISPLAY  
MATERIALS

An **inside bevel** has the honed side on the outside of the cut (the scrap side), while the straight, un-honed side is on the inside of the cut, or the “good side.”

An **outside bevel** reverses an inside bevel. It produces a straight cut on the inside, or good part, and a sloping cut on the outside edge, or scrap side (Figure 1e).

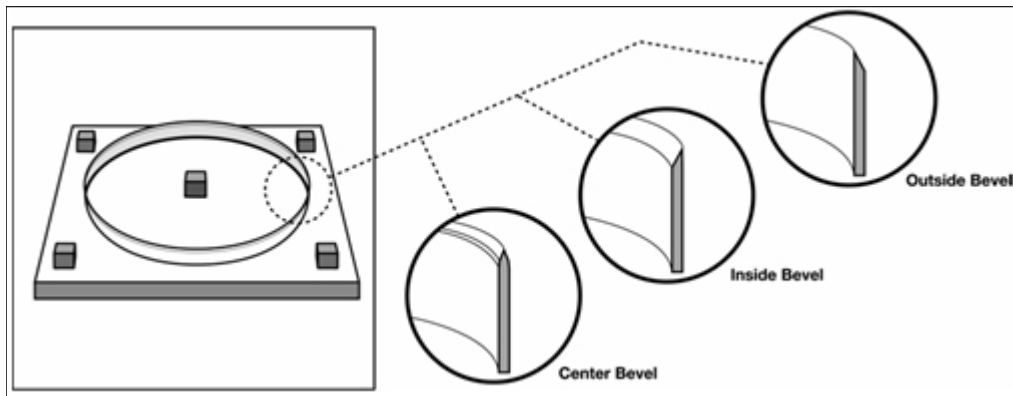

Figure 1e

**Bevel sharpness.** Steels used for SRD’s have a hardness of 57-59 Rockwell C. After much use, however, the knife will dull and produce cuts of increasingly poor quality. Re-sharpening knives is not recommended because it frequently results in an uneven edge and knife depth, even when the sharpening is performed by a skilled machinist. Even a slightly uneven edge will result in unequal penetration of the Celtec Material and thus in a ragged cut.

**TIP**

Do not re-sharpen knife blades. Always replace dull or worn knives with new ones to ensure even cuts.

**The backup plate.** Steel is often used to fabricate backup plates because the plate must not be too soft. However, steel plates can sometimes cause incomplete penetration of the Celtec, which also causes the material to fracture at the end of the cutting stroke. One method of avoiding this problem is to use a backup plate made from a sheet of Celtec or of chipboard placed over the steel backup plate. These softer materials enable the die to penetrate about 1/10” inch beyond the Celtec sheet, producing a cleaner cut (Figure 1f).

**Make ready.** Because of slight variations in thickness of a backup plate, the degree of knife penetration may vary throughout the cut. In order to produce a uniform cut, the backup plate should be built up to achieve even penetration by the die. The process of building up the backup plate to eliminate unevenness is call **make ready**, as explained below.

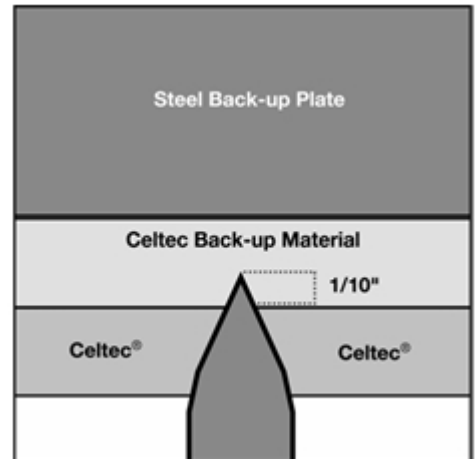

Figure 1f

**Make ready steps for die cutting:**

1. Securely mount the SRD on the upper or lower platen, as required, ensuring that it will not move during the die cutting.
2. On the opposite platen, firmly mount the die cutting plate, which should be 1/16" to 1/8" inches thick.
3. Using thin paper, such as Kraft wrapping paper, prepare the **make ready sheet**, which should be the exact size of the cutting plate. Position the make ready sheet on top of the cutting plate.

**NOTE!** IMPORTANT! Before proceeding, make certain that the press is not out of square (Figure 1g).

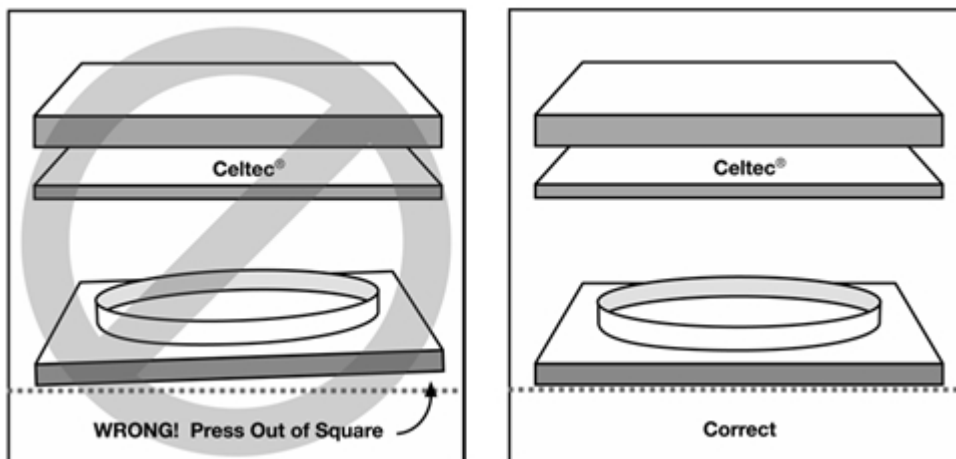

Figure 1g



4. Engage and adjust the press so that the die just touches, or “kisses”, the cutting plate. The die should leave an impression on the paper **without** leaving an impression on the plate. Usually only about two-thirds of the die pattern will leave its impression on the paper.

**TIP**

Do not attempt to make a complete impression of the die cut curing this step.

5. After the kiss cut, transfer the make ready sheet from the top of the cutting late to beneath the cutting plate, taking care that it is placed in the identical position in the press. Keeping the paper in the press will ensure that the exact knife depth required to cut the Celtec cleanly, as established in Step 4 with the paper in place, is maintained (Figure 1h).

6. Place a sheet of Celtec in the press and strike a part. If, upon inspection, you find an incomplete impression, the press can be lowered. Be sure, however, that the die just contacts the cutting plate.

7. Examine the cut Celtec. If portions of the perimeter have rough edges, follow the steps below:

- a. Remove the make ready sheet from beneath the cutting plate. Using the die-cut sample made is Step 6 as a guide, place single layers of cellophane tape on the make ready sheet in all areas where the cut is not clean. This selective taping will improve the cutting action in the problem areas.
- b. Re-insert the taped make ready sheet under the cutting plate and strike another sample, making certain that the cut just penetrates the Celtec sheet. If the cut is satisfactory, production is ready to begin. If roughly cut areas persist, repeat the taping procedure.

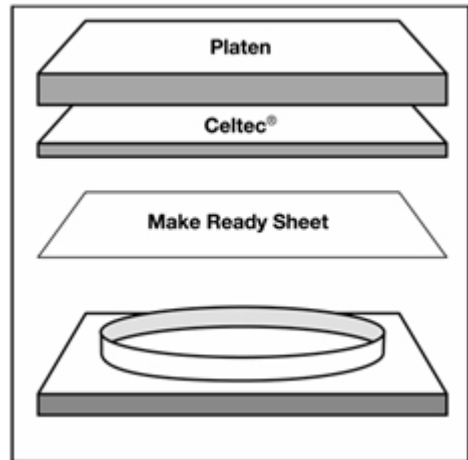

Figure 1h

**NOTE!**

Use a single layer of tape only. Do not overlap the tape strips or add tape to areas that are already cutting cleanly. Tape strips, or shims, may be necessary in areas in which the pattern to be die cut is intricate or has sharp bends or corners.

### Make Ready Tips

- When dies include intricate patterns and / or sharp bends, more pressure will be required to make the cut. Additional tape shims to build up the cutting plate may be needed in these areas (Figure 1i).
- Once the die is cutting cleanly, the make ready sheet should last throughout the entire job. If necessary, however, small imperfections can be rectified by applying additional cellophane tape to the specific problem areas.
- On completion of the job, file the make ready sheet together with the die. This will reduce setup time if the job is rerun.

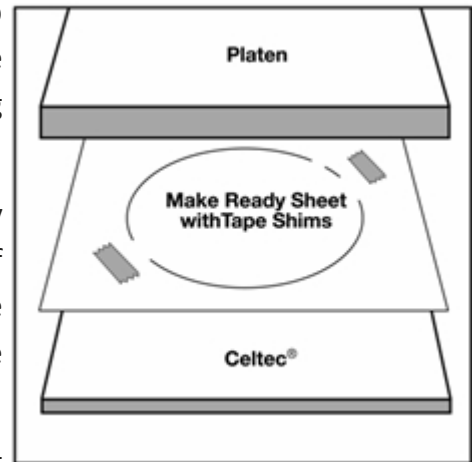

Figure 1i

<b>NOTE!</b>	<b>IMPORTANT!</b> Do not attempt to remedy cutting problems by shimming the back of the die. It is difficult to locate the exact area for tape placement, and in most cases, the die will wear through the tape and ruin the make ready sheet.
--------------	--

### Sawing

**Circular Saws.** For Celtec sheets 3MM and thicker, carbide-tipped, triple chip ground type chip ground type circular saws can be used (Figure 1j).

The following settings are recommended:

- **Rake angle: 0' to 15'**
- **Clearance angle: 10' to 20'**
- **Cutting speed: 8,000 to 12,000 feet per minute**
- **Feed: 70 to 90 feet per minute**



Figure 1j

**Band Saws.** High speed steel blades normally recommended for wood or plastic (hook type) can be used for Celtec material within the following guidelines.

# Processing

CELTEC®

- 4 to 8 teeth per inch.
- Cutting speed: 3,000 to 5,000 feet per minute.
- Feed: Up to 40 feed per minute.

**Saber Saws.** Rough cut type blades ground for plastics can be used on Celtec sheets. Smooth metal-cutting blades, however, will not produce acceptable results.

## Drilling

Celtec can be drilled with carbide-tipped bits using twist drills recommended for metals (Figure 1k). The following settings are recommended:

- Point angle: between  $90^\circ$  to  $110^\circ$
- Spiral angle:  $30^\circ$
- Relief angle:  $10^\circ$
- Cutting speed: 150 to 1,300 feet per minute
- Feed rate: 0.01" to 0.02" inches per revolution

Removing the drill from the material periodically may be necessary when drilling deeper holes so that frictional heat does not build up. Drill bits ground for normal PVC will not produce acceptable results.

Figure 1k

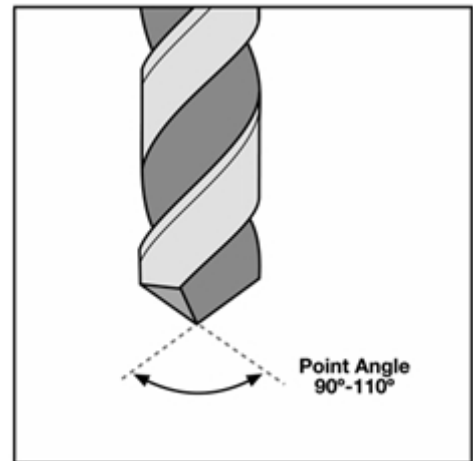

### TIP

For best results, drill bits should be kept sharp at all times.

## Milling

Celtec can be milled by using the following standard milling machines of various types within the following guidelines (Figure 1l).

- Relief angle:  $5^\circ$  to  $10^\circ$
- Rake angle:  $-10^\circ$  to  $0^\circ$
- Cutting speed: 3,000 to 3,500 feet per minute
- Cutting feed: 0.12" inches per revolution

Figure 1l

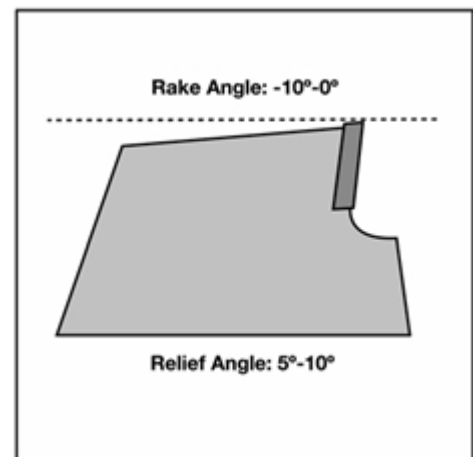

## Routing

Celtec material can be easily routed using multi-fluted carbide tools on standard woodworking routers. Standard tools and machines can be utilized without having to alter equipment bits (Figure 1m). Adjust feeds and speeds as needed to achieve the best edge finish on Celtec parts.

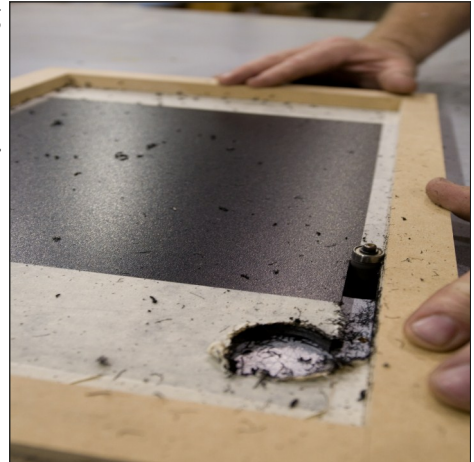

Figure 1m

## Edge Finishing

Edge finishing of Celtec can be accomplished using various sanding, filing, or grinding tools, such as a sander or file. Be careful not to overheat surfaces. Slight cell structure may be visible on cut edges of the Celtec material.

### TIP

**IMPORTANT!** When machining Celtec material, secure hold downs so that the force is spread out over a large area.

## Laser Cutting

Please consult the laser cutting equipment manufacturer prior to use.

## Waterjet Cutting

Celtec is easily cut using water jet equipment. Water jet offers higher tolerance accuracy, of up to +/- 0.5mm, with no material waste. Multiple sheets can be stacked to obtain faster cutting times to increase machine efficiency.

## Manufacturers

### Sawing Equipment

Company	Telephone	Address
Forrest Manufacturing Company <a href="http://www.forrestblades.com">www.forrestblades.com</a>	973.473.5236 F: 973.471.3333	457 River Road Clifton, NJ 07014
Hendrick Manufacturing Corporation <a href="http://www.hendrickmanufacturing.com">www.hendrickmanufacturing.com</a>	978.741.3600 F: 978.744.0242	36 Commercial Street Salem, MA 09170
Stiles Machinery <a href="http://www.stilesmachinery.com">www.stilesmachinery.com</a>	616.698.7500 F: 616.698.9411	3965 44th Street SE Grand Rapids, MI 49512

### Die Cutting Equipment

Company	Telephone	Address
Porth Products <a href="http://www.porthproducts.com">www.porthproducts.com</a>	269.657.3985 F: 269-657-6179	56285 Fairway Drive Pawpaw, MI 49079
Thomson National Press Company <a href="http://www.thethomsongroup.com">www.thethomsongroup.com</a>	508.528.2000 F: 508.520.7129	115 Dean Avenue   Franklin, MA 02038

### Router Equipment

Company	Telephone	Address
Onsrud Cutter LP <a href="http://www.onsrud.com">www.onsrud.com</a>	800.234.1560 F: 800.557.6720	1081 S. Northpoint Boulevard Waukegan, IL 60085
Eagle America Corporation <a href="http://www.eagleamerica.com">www.eagleamerica.com</a>	800.872.2511 F: 800.872.9471	2381 Philmont Avenue Suite 107 Huntington, PA 19006

[This page intentionally left blank.]

In this chapter, various methods of fastening Celtec are covered as well as important details to consider during the fabrication process. With the numerous uses for Celtec and the differing environments of service, it is important to take into account Celtec's thermoplastic properties during fabrication and installation.

## Notch Sensitivity

When designing a Celtec part, It is important to maintain a smooth radius corner along the perimeter edge or in the slotted areas (Figure 2a). Using a sharp corner angle or scored line is not recommended and can result in fracturing of the Celtec material. With thinner sheets of Celtec, radii as small as 1/8" generally can be cut without difficulties.

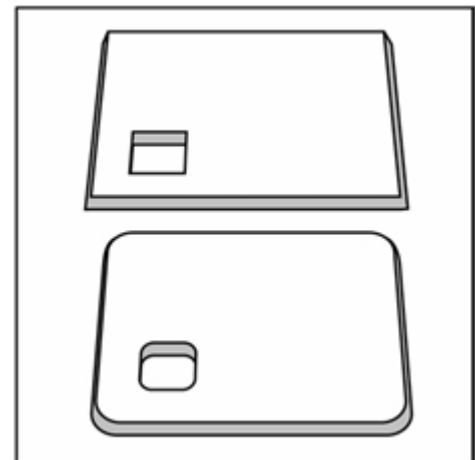

Figure 2a

## Celtec Thermal Expansion / Contraction

Because it is a cellular, or foamed, rigid polyvinyl chloride sheet product, Celtec will expand or contract with an increase or a reduction in temperature, as is common with all plastic materials. When the temperature change is reversed, the material returns to its original dimensions. This property is called **linear thermal expansion and contraction**.

Because Celtec can be used in a wide variety of indoor and outdoor applications, linear thermal expansion and contraction may need to be considered during the fabrication and installation of the material. Important variables are the temperature at which the Celtec was machined as well as the temperature range of the environment in which the Celtec is installed.

In a location with a relatively constant temperature and not in direct sunlight, such as an indoor display stand, any thermal expansion and contraction of the Celtec material will usually not be significant.

If, however, a finished Celtec project will be used in a setting that has noticeable fluctuations in temperature, the potential expansion and contraction should be considered when producing the part (s). Expansion of the Celtec material occurs when it is placed in an environment with higher temperatures than the temperature at which it was originally cut. Conversely, contraction, or shrinkage, of the material takes place when it is in a colder environment than that in which it was cut.

**NOTE!**

Calculations for thermal expansion and contraction should be made for both the width and the length of the Celtec material.

Celtec should not be used in areas that exceed 140°F, at which temperature the Celtec will soften and change dimension permanently. **Dark colors are generally not recommended for outdoor use, as they absorb heat energy and can easily exceed the maximum allowable temperature of 140°F.**

**NOTE!**

When exposed to direct sunlight, white Celtec will generally show a surface temperature 10°F to 20°F higher than the actual air temperature.



## Celtec Thermal Expansion / Contraction Worksheet

The following worksheet will help calculate the correct size to cut a Celtec part in order to allow for potential expansion and contraction after installation.

Expansion:	
1. Highest expected temperature in the environment in which the Celtec part will be used (in degrees Fahrenheit).	F°
2. Approximate temperature of the Celtec part at the time it was cut (in degrees Fahrenheit).	F°
3. Total temperature difference (subtract line 2 from line 1)	F°
4. Total length of Celtec part (in inches)	in.
5. <b>Total amount of expansion (line 3 x line 4 x 0.00004)</b>	<b>in.</b>

Contraction	
1. Approximate temperature of the Celtec part at the time it was cut (in degrees Fahrenheit)	F°
2. Lowest expected temperature in the environment in which the Celtec will be used (in degrees Fahrenheit)	F°
3. Total temperature difference (subtract line 2 from line 1)	F°
4. Total length of Celtec part (in inches)	in.
5. <b>Total amount of expansion (line 3 x line 4 x 0.00004)</b>	<b>in.</b>

### Conversion Table: Decimal to Fractional Inches

0.032" = 1/32"	0.156" = 5/32"	0.281" = 9/32"	0.406" = 13/32"
0.063" = 1/16"	0.187" = 3/16"	0.312" = 5/16"	0.438" = 7/16"
0.093" = 3/32"	0.218" = 7/32"	0.343" = 11/32"	0.469" = 15/32"
0.125" = 1/8"	0.250" = 1/4"	0.375" = 3/8"	0.500" = 1/2"

**Celtec Thermal Expansion / Contraction Worksheet Example:**

A Celtec part is cut in a shop where the temperature is 70°F. The part is 96” inches long. The part will be installed as part of an outdoor sign on a concrete building. The highest expected temperature after installation is 100°F, and the lowest expected temperature is 10°F.

<b>Expansion:</b>	
1. Highest expected temperature in the environment in with the Celtec part will be used (in degrees Fahrenheit).	100 F°
2. Approximate temperature of the Celtec part at the time it was cut (in degrees Fahrenheit).	70 F°
3. Total temperature difference (subtract line 2 from line 1)	30 F°
4. Total length of Celtec part (in inches)	96 in.
5. <b>Total amount of expansion (line 3 x line 4 x 0.00004)</b>	<b>0.015 in.</b>

<b>Contraction</b>	
1. Approximate temperature of the Celtec part at the time it was cut (in degrees Fahrenheit)	70 F°
2. Lowest expected temperature in the environment in which the Celtec will be used (in degrees Fahrenheit)	10 F°
3. Total temperature difference (subtract line 2 from line 1)	60 F°
4. Total length of Celtec part (in inches)	96 in.
5. <b>Total amount of expansion (line 3 x line 4 x 0.00004)</b>	<b>0.230 in.</b>

Using the worksheet and converting the results to fractional inches, the maximum amount of expansion of the 96” part will be approximately 1/8”, and the minimum amount of contraction will be approximately 1/4”. To allow for this expansion and contraction, the Celtec sign should not be fastened directly to the concrete exterior wall, as it might then buckle, crack or warp during temperature fluctuations. In this example, slots for fasteners or U-channel tracking should be cut to allow the part to expand up to 96-1/8” and contract to 95-3/4”.

Celtec Linear Expansion / Contraction Quick Reference:				
Total Temperature Change (+/-)	Expansion / Contraction of Material at Standard Lengths / Widths (in inches)			
	48 inches	60 inches	96 inches	120 inches
20°F	0.038"	0.048"	0.076"	0.096"
40°F	0.077"	0.096"	0.154"	0.192"
60°F	0.115"	0.144"	0.230"	0.288"
80°F	0.154"	0.192"	0.308"	0.384"
100°F	0.192"	0.240"	0.384"	0.480"
120°F	0.230"	0.288"	0.460"	0.576"
140°F	0.269"	0.336"	0.538"	0.672"

## Screwing and Nailing

Any type of screw or nail can be used to fasten Celtec material: pre-drilling is typically unnecessary. Power nailers and screw driving equipment are suggested. Inserting the screw or nail in an elongated slot or an oversized hole is recommended so that the material can expand or contract if fluctuations in temperature occur (Figure 2b). For best results, use oversized washers or grommets in combination with screws.

Screws should be tightened and then retightened slightly to allow the Celtec material to expand or contract as necessary.

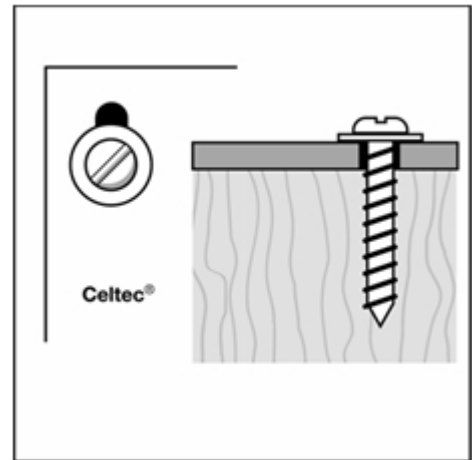

Figure 2b

In small panels under 18" inches or in temperature-controlled environments, allowing for expansion and contraction is not mandatory. Mechanical failures in heating or cooling systems and other unexpected factors can, however, affect temperatures radically and may cause unanticipated expansion or contractions.

Nailing is suggested for small, thin panels of Celtec material. To use larger nails and screws, holes should be placed at least one inch from any edges and predrilled (Figure 2c). Celtec is more brittle in colder temperatures, so if work is being completed outdoors in low temperatures, be careful to avoid possible fracturing of the Celtec material.

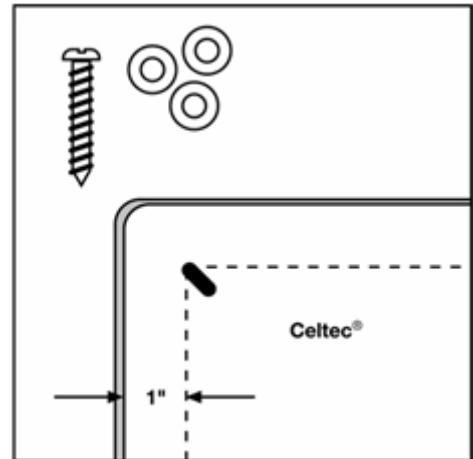

Figure 2c

## Installation

Celtec is manufactured as an extruded PVC product with a directional grain running the entire length of the sheet. This manufacturing process gives Celtec greater flexural strength in the direction of the extrusion. Because of this characteristic, flag-type signs should be cut so that the grain direction is horizontal to the anchor point (Figure 2d). This precaution permits the Celtec material to flex and withstand wind pressure.

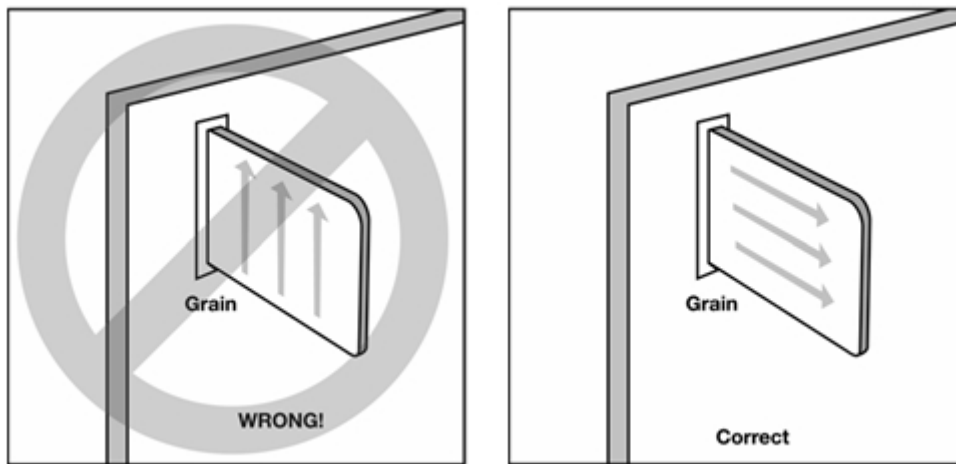

Figure 2d

**NOTE!**

Failure to cut and attach the material in the proper direction may cause fracturing to occur, particularly in narrow signs.

## Bonding and Adhesives

### Celtec to Celtec or other PVC material

For bonding Celtec to itself or another PVC material, a solvent-based adhesive system used for rigid, non-expanded PVC will provide the best results. Solvent-based adhesives are sold through various suppliers. Proper ventilation and a clean working environment are essential for this type of bonding.

**NOTE!**

When bonding large panels face to face, avoid using solvent-based adhesives, which will not cure properly.

### Celtec to various substrates

There are numerous types of adhesives that can be used with specific substrates. Contact, epoxy, rubber-base and urethane adhesive systems are all acceptable. For best results, test the selected adhesive for suitability in a particular application before use.

Parts to be joined should fit without forcing and be prepared with the appropriate cleaner. Depending on the type of application and the consistency of the adhesive, the adhesive can be applied to the material with a brush, a syringe or and eyedropper. If cement is applied to one surface, let the two surfaces be in gentle contact for a few seconds to allow the cement to soften the dry surface, then press parts together in firm contact (Figure 2e).



Figure 2e

**NOTE!**

When using any adhesive system, be certain to follow the manufacturer's storage and handling recommendations. Disposing of spent adhesives or solvents may be subject to local regulations.

## Weld-On® Adhesive Selections

The table below details the individual Weld-On® adhesives best used to bond Celtec to various materials.

Celtec Material Bonding Chart										
Material	Weld-On® Product Number									
	10	16	40	45	66	1001	1007	2007	4007	4052
ABS	X	X	X	X	X	X				X
Acrylic Cell Cast	X	X	X	X		X				
Acrylic Cross-Linked			X	X		X				
Acrylic Extruded	X	X	X	X		X				
Butyrate	X	X	X	X	X					
Concrete	X			X		X				
Fiberglass	X			X		X				
Metal	X			X		X				
PETG	X	X	X	X						
Polycarbonate	X	X	X	X						
Polyester	X		X	X						
Polyurethane					X					
PVC (Rigid)	X	X	X	X		X	X	X	X	X
PVC (Flexible)	X			X		X		X		X
PVC (Foamed)	X	X	X	X	X	X	X	X	X	X
Styrene	X	X		X						X
Wood				X	X	X				

# Fastening

CELTEC®



Weld-On Product Number	Color	Body	Typical Viscosity (CPS)	Typical Sp. Gr.
10	White	Two-part, reactive, high strength, structural adhesive	40,000	1.03
16	Clear	Fast-setting, high strength, acrylic plastic cement	800	1.08
40	Clear	Two-part, reactive, high strength acrylic cement	2,900	1.03
45	Off-white	Two-part, reactive, high strength, structural adhesive	500,000	1.10
66	Clear	Thin, fast-setting, flexible, vinyl contact cement	260	0.85
1001	Clear	Thin-bodied, slow curing, high strength, cement	400	0.93
1007	Clear	Thin-bodied, fast-drying, vinyl cement	100	0.90
2007	Clear	Water thin, fast-setting, solvent cement	Water Thin	0.85
4007	Clear	Thin-bodied, fast-setting, vinyl cement	850	0.98
4052	Amber	Medium-bodied, fast-setting, cement	850	0.98

Weld-On® is a registered trademark of IPS Corporation (455 W. Victoria Street, Compton, CA 90220) 310.898.3300, F: 901.853.5008, [www.ipscorp.com](http://www.ipscorp.com)

## Adhesives and Manufacturers

The following tables list several adhesives and their bonding applications for materials commonly used in fabricating Celtec products.

The second table contains contact information for the manufacturers of those products. Additional adhesive manufacturers are listed in the third table.

The listed adhesives and manufacturers are for informational purposes only. Please perform the appropriate tests to ensure that the materials will produce the desired results.

Celtec Recommended Adhesives and Applications										
Manufacturer	Adhesive	Celtec To:								
		Celtec	Rubber	Glass	Aluminum	Metal	Masonry	Other Plastics	Wood /	High Pressure
3M Adhesive Division	3M Scotch-Weld 2216B/A, 3549 B/A (structural bond)	X	X			X	X	X	X	
	3M Scotch-Grip 4475, Fast Bond 30 Neutral (nonstructural bond)								X	
	Fast Bond 30-NF Green Contact Adhesive	X		X				X	X	X
Daubert Chemical Co.	Daubond 8050	X			X	X		X	X	
	Daubond 8855	X				X		X	X	
Dow Corning Corp.	832	X						X		
E-Z Weld	E-Z Weld	X								
GE Silicones	Silicone II Window and Door	X		X	X	X		X	X	
Gorilla Glue	Gorilla Glue	X		X	X	X	X	X	X	
	Gorilla Super Glue	X	X		X	X		X	X	
	Gorilla Epoxy	X		X	X	X	X	X	X	
Henkel Loctite Corp.	Prism 454 Surface Instant Gel	X				X		X	X	
	Speedbonder 324, 325, 326 (structural bond)	X						X		
Oatey Co.	PVC and ABS and CPVC All Purpose Cement	X						X		
National Casein	PVC-E4HV	X								
Sashco	Lexel	X		X	X	X		X	X	
Satellite City	Hot Stuff Super T, Special T	X						X	X	
Schwartz Chemical Co.	VC1, VC2	X								
	Rez-n-Bond			X	X	X		X	X	
TEC Specialty Products	Max Bond	X		X	X	X		X	X	



## Recommended Adhesive Manufacturers

Company	Contact	Address
3M Adhesives <a href="http://www.3m.com">www.3m.com</a>	800.362.3550 F: 651.733.9175	3M Corporate Headquarters / 3M Center St. Paul, MN 55144
E-Z Weld Inc. <a href="http://www.e-zweld.com">www.e-zweld.com</a>	561.844.0241 F: 561.848.8950	1661 Old Dixie Highway Riviera Beach, FL 33404
Daubert Chemical Co. <a href="http://www.daubertchemical.com">www.daubertchemical.com</a>	800.914.0034 F: 708.496.7367	4700 S. Central Avenue Chicago, IL 60638
GE Silicones Inc. <a href="http://www.siliconeforbuilding.com">www.siliconeforbuilding.com</a>	877.943.7325	9930 Kinsey Avenue Huntersville, NC 28078
Henkel Loctite Corp. <a href="http://www.loctite.com">www.loctite.com</a>	847.648.9200 F: 847.648.9819	Contact local dealers
National Casein <a href="http://www.nationalcasein.com">www.nationalcasein.com</a>	773.846.7300 F: 773.487.5709	601 West 80th Street Chicago, IL 60620
Oatey Company <a href="http://www.oatey.com">www.oatey.com</a>	800.321.9532 F: 216.267.6538	4700 West 160th Street Cleveland, OH 44135
Sashco <a href="http://www.sashco.com">www.sashco.com</a>	800.289.7290 F: 303.286.0400	10300 107th Place Brighton, CO 80601
Satellite City <a href="http://www.caglue.com">www.caglue.com</a>	800.786.0062 F: 888.200.9413	3543 Old Conejo Road, STE 101 Newbury Park, CA 91320
Schwartz Chemical Company <a href="http://www.schwartzchem.com">www.schwartzchem.com</a>	905.683.0411 F: 905.428.2057	777 McKay Road Pickering, Ontario, Canada LIW 3A3

## Additional Adhesive Manufacturers

Company	Contact	Address
Bostik Findley, Inc. <a href="http://www.bostik-us.com">www.bostik-us.com</a>	414.774.2250	11320 Watertown Plank Road Wauwatosa, WI 53226
IPS <a href="http://www.ipscorp.com">www.ipscorp.com</a>	800.888.8312 F: 901.853.5008	455 W. Victoria Street Compton, CA 90220
Liquid Nails <a href="http://www.liquidnails.com">www.liquidnails.com</a>	800.634.0015	15885 West Sprague Road Strongsville, OH 44136
Parabond <a href="http://www.parabond.com">www.parabond.com</a>	800.763.7272	PO BOX 127, 863 SE Main Street Simpsonville, SC 29681
TACC <a href="http://www.itwtacc.com">www.itwtacc.com</a>	800.503.6991 F: 800.231.8222	56 Air Station Industrial Part Rockland, MA 02370



## Additional Manufacturers of Adhesives Specific to Celtec 550

Company	Contact	Address
AmBel Corporation <a href="http://www.excelglue.com">www.excelglue.com</a>	800.779.3935	10751 N. Territorial Dexter, MI 48130
OSI Sealants, Inc. <a href="http://www.osipro.com">www.osipro.com</a>	800.624.7767	7405 Production Drive Mentor, OH 44060
Siroflex, Inc. <a href="http://www.siroflexinc.com">www.siroflexinc.com</a>	800.359.6389 F: 864.458.9092	1320 Garlington Road Greenville, SC 29615
White Lightning (KPG) <a href="http://www.kpg-industrial.com">www.kpg-industrial.com</a>	800.777.2966 F: 800.243.3075	101 Prospect Avenue Cleveland, OH 44115

## 3

Celtec can easily be shaped using conventional methods, such as heat bending, pressure forming, and vacuum forming. Because Celtec heats and cools very quickly, which creates very fast cycle times reducing labor, making the material excellent for sign faces and point-of-purchase displays.

### Heat Bending

Celtec sheet material can be bent by using Calrods, radiant heaters, strip heaters (Figure 3a) or air-circulated ovens. Heat guns can also be used on small areas. To ensure best results, a rheostat should be used to control heating of the Celtec so that the surface temperature does not exceed 340°F.



Figure 3a

When using metal contact strip heater, cover the heater strip with Teflon spray to prevent marking the Celtec. Different sizes of rectangular heating bars can be used to produce bends of different radii. The larger the heated area of the Celtec, the larger the radius that can be created.

Celtec should be heated from both sides when the sheet is thicker than 4mm. Celtec heats much more quickly than solid PVC's or acrylics and requires heating at the rate approximately 30 to 40 seconds per millimeter of thickness prior to bending.

**NOTE!**

Heating Celtec material over 340°F can cause the surface to become rough and possibly discolor.

To form tighter bends with smaller radii, use a smaller heated area on the upper surface (inside the bed) of the Celtec sheet and a larger heated area on the bottom surface (on the outside of the beds) of the sheet. A minimum radius of twice the sheet thickness is necessary to avoid breakage (Figure 3b). When bending Celtec into an angle, typically the extension of the Celtec on either side of the angle should be at least 20 times the thickness, when the entire sheet is heated.

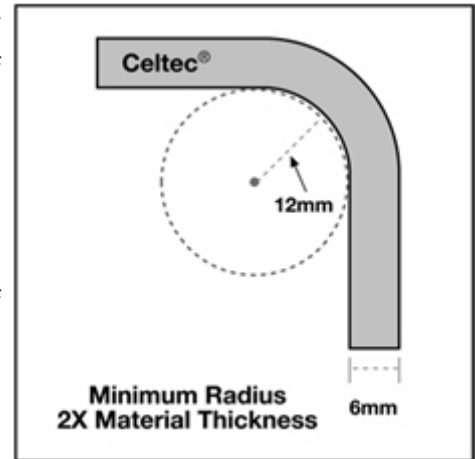

Figure 3b

Once Celtec is bent, place it in a fixture, such as a jig or clamp, to cool. Fans and / or compressed air will speed the cooling process.

### Pressure or Drape Forming

Celtec can be heated using radian heat panes or air circulating ovens. Either male or female molds can be coupled with plug assists or forced air to form parts (Figure 3c). This procedure is recommended for simple shallow forms with low definition. Conventional equipment used for thermoplastics is also ideally suited for Celtec.

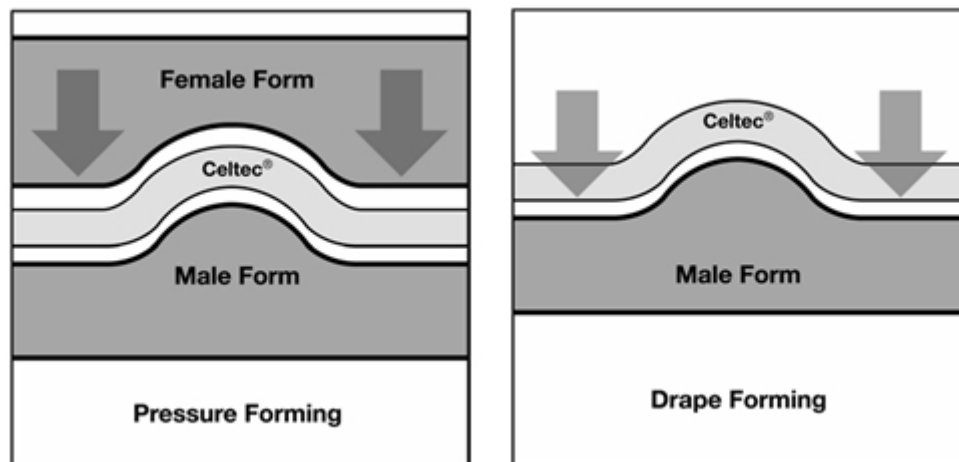

Figure 3c

**NOTE!** When using radiant heaters, be careful not to overheat the surface.

If the Celtec material is over 4mm thick, both sides of the sheet should be heated (Figure 3d). When heating from only one side, the top heater should be set at 750°F or below. With two-sided heating, the top heater should be at 750°F and the bottom heater at 650°F. If using an air-circulated oven, the temperature should be between 260°F and 280°F.

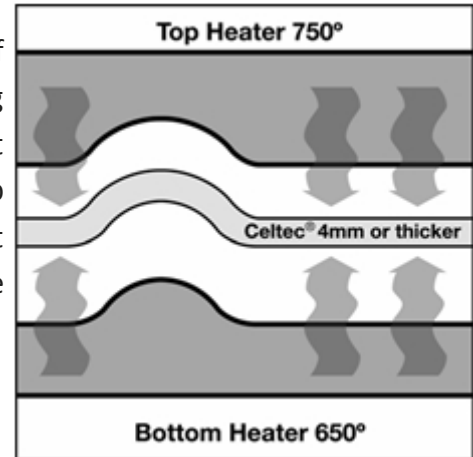

Figure 3d

After the Celtec is heated, place it immediately into the mold. The male mold should have a draft angle of at least 5 degrees. Depending upon the part to be formed, the Celtec material may need to be larger than the mold to allow for shrinkage and / or clamping.

Because there are limits to the Celtec material's ability to stretch while still producing aesthetically acceptable results, the depth of the part that can be successfully created will depend upon both the mold and the part's design.

Cycle times for Celtec are very fast, approximately 15 to 20 seconds per millimeter of thickness with radiant heaters and 30 to 40 seconds per millimeter in air circulating ovens.

**NOTE!** When creating or selecting a mold for Celtec material, it is important to use a mold without sharp corners.

## Vacuum Forming

Vacuum forming of Celtec is similar to pressure forming except that it is generally used when greater part detail and dimensional repeatability are necessary (Figure 3e). The forming temperature for Celtec is also higher, generally 300°F to 340°F. Exceeding 340°F is not recommended because it can cause bubbling of the Celtec surface.

Molds for vacuum forming are generally made of wood or plaster for short life short runs and of nonferrous metals for long life long runs. For metals, aluminum is generally the material of choice. Molds should be designed with radii at least two times the material thickness and draft angles of 5° or greater. Vacuum holes should not exceed 1/32" in diameter.

Figure 3e

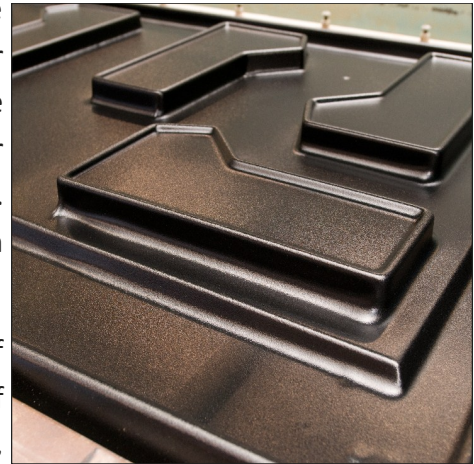

## Heat Welding

Celtec can be joined using fusion welding, ultrasonic welding and hot gas welding.

For Celtec thickness over 6mm, butt fusion welding is recommended. In general, the pressure used for solid PVC must be reduced for expanded PVC. Exact recommendations are dependent on the length and thickness of the Celtec part to be welded. For more precise information, contact Wegener North America.

Ultrasonic welding technology is based on the principal of converting electrical energy into mechanical energy for the purpose of changing the physical, chemical, or biological properties of materials or systems. Key benefits of HPU (High Power Ultrasonic) include friction reduction, solid state bonding, extremely fast cycle times, and real-time feedback. For more information contact Edison Welding Institute. and Wegener Welding

**Edison Welding Institute**  
1250 Author E. Adams Drive  
Columbus, OH 43221  
614.688.5000  
[www.ewi.org](http://www.ewi.org)

**Wegener Welding**  
16W301 S. Frontage Road  
Burr Ridge, Illinois 60527  
630.789.0990  
[www.wegenerwelding.com](http://www.wegenerwelding.com)

# Forming / Welding

CELTEC®



Hot gas welding can be performed with a hot air gun and welding rod (Figure 3f). The air should be clean and free of all contaminants. If the air is not clean, an inert gas such as nitrogen can be used. The welding temperature and volume of air should be adjustable. Celtec welds ideally with a Type II welding rod but also can be welded with a Type I welding rod. The weld strength is approximately 60% of the base material.

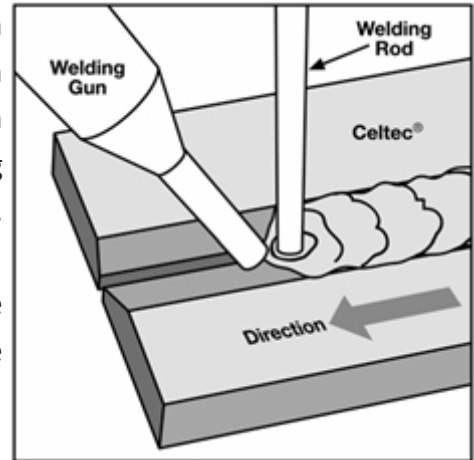

Figure 3f

The Celtec sheets to be welded should be free from dust or oil. For butt welding using the hot gas method, sheets should be chamfered using a table saw, milling machine or router. The angle should be 60° for round bends and 80° for triangle bends with corner welds at right angles (Figure 3g). The chamfer should be at 45°.

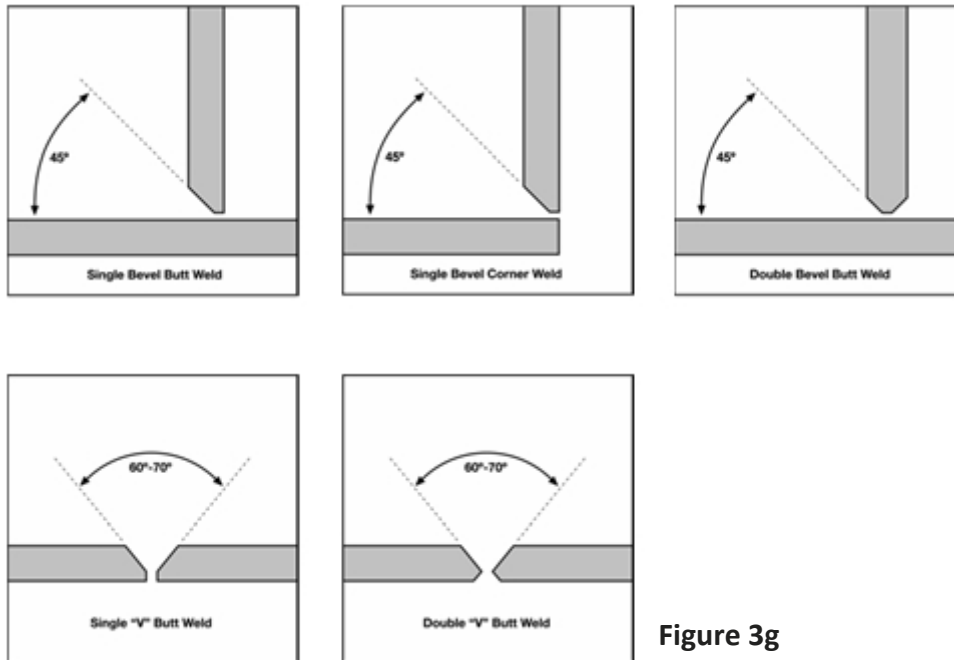

Figure 3g

To weld Celtec material, feed the rod through the gun and apply pressure on the rod as the sheet and rod are heated simultaneously. The temperature of the gas should be at 680°F when measured 3/16” inside the tip of the gun. The volume of air should be 50 liters per minute using a flow regulator with welding pressure at approximately 2 to 3-1/2 lbs., depending on the rod diameter. Following these guidelines, welding speeds between 11 to 20 inches per minute are possible.

**NOTE!** Skiving off the weld joint for aesthetic purposes will reduce weld strength.

## Manufacturers

### Bending and Forming Equipment

Company	Contact	Address
C.R. Clarke & Co., Inc. <a href="http://www.crclarke.co.uk">www.crclarke.co.uk</a>	800.676.7133 F: 407.566.0756	1272 Aqula Loop Kissimmee, FL 34747
Kamweld Technologies, Inc. <a href="http://www.kamweld.com">www.kamweld.com</a>	781.762.6922 F: 781.762.0052	90 Access Road Norwood, MA 02062
Wegener North America, Inc. <a href="http://www.wegenerwelding.com">www.wegenerwelding.com</a>	630.489.0990 F: 630.789.1380	16W231 S. Frontage Road, Unit 12 Burr Ridge, IL 60527

### Thermoforming Equipment

Company	Contact	Address
Brown Machine LLC <a href="http://www.brown-machine.com">www.brown-machine.com</a>	989.435.7741 F: 989.435.2821	330 North Ross Street Beaverton, MI 48612
Lamco Machine Tool Inc. <a href="http://www.lamcomachine.com">www.lamcomachine.com</a>	252.247.4360 F: 252.247.4633	135 Industrial Drive Morehead City, NC 28557
MAAC Machinery Corporation <a href="http://www.maacmachinery.com">www.maacmachinery.com</a>	800.558.6222	590 Tower Boulevard Carol Stream, IL 60188



## Line Bending Equipment

Company	Contact	Address
Big Chief Supply Company <a href="http://www.gobigchief.com">www.gobigchief.com</a>	800.835.4328 F: 513.271.0790	5150 Big Chief Drive Cincinnati, OH 45227
Craftics Inc. <a href="http://www.craftics.net">www.craftics.net</a>	505.338.0005 F: 505.338.0008	2804 Richmond Drive NE Albuquerque, NM 87107
FTM, Inc. / Westedge <a href="http://www.thefabricatorssource.com">www.thefabricatorssource.com</a>	530.626.1986 F: 530.642.2602	327 Industrial Drive, Unit 1 Placerville, CA 95667
Kamweld Technologies, Inc. <a href="http://www.kamweld.com">www.kamweld.com</a>	781.762.6922 F: 781.762.0052	90 Access Road Norwood, MA 02062
Watlow Electric Manufacturing Co. <a href="http://www.watlow.com">www.watlow.com</a>	800.928.5692 F: 314.878.6814	12001 Lackland Road St. Louis, MO 63146

## Welding Equipment

Company	Contact	Address
Kamweld Technologies, Inc. <a href="http://www.kamweld.com">www.kamweld.com</a>	781.762.6922 F: 781.762.0052	90 Access Road Norwood, MA 02062
Laramy Products Co., Inc. <a href="http://www.laramyplasticwelders.com">www.laramyplasticwelders.com</a>	802.626.9328 F: 802.626.5529	40 Sandy Lane Lyndonville, VT 05851
Seelye Inc. <a href="http://www.seelyeplastics.com">www.seelyeplastics.com</a>	800.328.2728 F: 952.881.3503	9700 Newton Avenue South Bloomington, MN 55431
Wegener North America, Inc. <a href="http://www.wegenerwelding.com">www.wegenerwelding.com</a>	630.489.0990 F: 630.789.1380	16W231 S. Frontage Road, Unit 12 Burr Ridge, IL 60527

## Ultrasonic Equipment

Company	Contact	Address
Branson / Emerson Industrial <a href="http://www.emersonindustrial.com">www.emersonindustrial.com</a>	203.796.0400 F: 203.796.9838	41 Eagle Road Danbury, CT 06810
Dukane Corporation <a href="http://www.dukane.com">www.dukane.com</a>	630.584.2300	2900 Dukane Drive St. Charles, IL 60174
Herman Ultrasonics Inc. <a href="http://www.herrmannultrasonics.com">www.herrmannultrasonics.com</a>	630.626.1626 F: 630.626.1627	1261 Hardt Circle Bartlett, IL 60103
Sonobond Ultrasonics Inc. <a href="http://www.sonobondultrasonic.com">www.sonobondultrasonic.com</a>	800.323.1269 F: 610.692.0674	1191 McDermott Drive West Chester, PA 19380

[This page intentionally left blank.]

# 4

Celtec performs outstandingly in a wide range of graphic applications including those involving paints, screen printing, digital flatbed printing and vinyl films. Celtec can be used to create weather-resistant signs, displays or Point of Purchase (POP) materials. The smooth Celtec surface is ideal for all types of graphics, and it requires little surface preparation or surface treatment.

## General Considerations

To ensure best results for any graphic applications using Celtec, consider the following factors that may affect the finished installation:

- Environmental and safety concerns.
- Weathering
- Chemical resistance
- Ease of application
- Cost-effectiveness
- Hardness
- Scratch resistance
- Priming or multicoated paint applications.

## Cleaning / Pretreating

Before screen printing or painting Celtec, the surface area should be cleaned with isopropyl alcohol and a clean white cloth. Depending on the specific application, certain pretreatments may also be required, as described in the following sections.

### TIP

Because of the wide range of products available, select paints carefully for each application. Initial testing of the selected paint system is recommended before a product run.

## Digital Flatbed Printing

Digital ink jet printing has grown in popularity for printing signs, POP displays, exhibits, Point of Sale signs, etc. The technology has advanced very rapidly to increase printing speeds, offer higher DPI, offer white ink technology for dark substrates and reduce the capital investment required to buy a machine.

Since Celtec is a rigid substrate, it requires a flatbed feed system. Most of today's equipment manufacturers offer machines that can print materials up to 2" thick (Figure 4a). Digital printing allows

shorter production runs compared to screen printing. Customers who have digital flatbed printers can print directly from a PC to the substrate, which eliminates costly setup.



Figure 4a

### Standard Celtec is ideal for flatbed printing for the following reason:

- Direct printing to Celtec eliminates the mounting and laminating steps necessary when printing to paper.
- Celtec can be used with UV curing machines or screen print solvent systems. Always check with the manufacturer before printing for compatible solvent-based ink systems.
- Celtec has the best whiteness for reproducing choice colors.

## Digital Printing Equipment

Most of the machines today use UV curing inks, although there are some that use solvent systems. Most equipment companies have proprietary inks that are used with their equipment, and it is therefore impossible to cover all of the combinations. See the table at the end of the chapter for a list of equipment that has run Celtec at the equipment's manufacturing site or is used in the field by our customer base.

## Printing

Celtec provides an excellent surface for screen printing and accepts a wide range of inks (Figure 4b). When silk-screening on Celtec, crisp, full coverage is achieved with printing inks that normally would be used for other rigid PVC products.

For best results when screen printing, be sure that the Celtec sheet has been degreased and cleaned with a lint-free cloth. Always use PVC screen inks and thinners from the same product line and manufacturer. Incompatibility of inks and thinners may cause poor print quality, surface cracking and reduce the life span of the Celtec material.



Figure 4b

### TIP

Celtec in the 10MM thickness and above provides an extremely smooth surface for printing.

## Painting / Varnishing

Although Celtec requires no painting, any painting planned for a project should be completed as soon as possible, either during or soon after the construction process. Priming is not mandatory but should be performed prior to painting if the paint manufacturer's warranty is a consideration. In order to avoid heat buildup, light paint colors are recommended for most applications. Sheets of 19MM and greater thickness can accept slightly darker colors, but not very dark (i.e. black, brown, forest green, etc.).

Paint adheres to Celtec material exceptionally well. In general, no primers are needed to prepare the Celtec sheet for painting, although the surface of the Celtec should be dry, clean and degreased for best results. Any method of paint application may be used, including power or manual rollers, spray, guns, conventional brushes, sponge-type brushes, artists' lettering brushes and / or dipping.

### TIP

A sample of Celtec should be flood-screened prior to production to ensure a finished product of acceptable quality.

One type of paint has shown a significant advantage as a UV reflective coating. Test data shows that surface temperatures are reduced drastically when Reno-Coatings' Prolux Series 32000 is used. Because it is very expensive, spraying this paint will help reduce costs. In certain applications, however, the Prolux Series 32000 can allow Celtec to be painted a dark color and used outdoors. Proceed with caution, and test each specific application before a final production run. (See the Paint Manufacturers table and Addenda at the end of this chapter for contact details and test data on Reno Coatings and Blue River Coatings UV reflective paints).

Apply paint in only one direction if using a brush (Figure 4c). Celtec material generally requires only one coat of paint to finish.

<b>NOTE!</b>	Most enamels and lacquers systems are generally not recommended for Celtec.
--------------	---

Celtec is a thermoplastic material that will deform at temperatures above 140°F and thus cannot be heat dried at high temperatures. Air dry paints are therefore most successful with Celtec material.

### Surface Preparation

Before painting or printing, clean the surface of the Celtec material with a clean cloth and an aliphatic solvent, such as isopropyl or denatured alcohol, heptane, octane, UM&P or naphtha, in order to produce good adhesion.



Figure 4c

<b>NOTE!</b>	Remove any scratches on the Celtec material's surface by sanding with a fine sandpaper or by rapidly fanning the area with a heat gun. Once sanded, the original finish is removed.
--------------	---

## Cross Hatch Adhesion Test

Good paint and ink adhesion is critical to achieving a successful finished product. The cross hatch adhesion test described below should be performed on every paint or ink system unless it is specifically recommended for Celtec material. For paint and ink brands, consult the list of recommended manufacturers at the end of this chapter.

**NOTE!**

Although most paints will feel dry to the touch after 24 hours, some paints may not achieve full adhesion to the Celtec material for two to three weeks after application.

1. On a sheet of Celtec, apply the paint to be tested for adhesion. Let dry for a minimum of 48 hours.
2. Using a knife with a replaceable blade, make 11 parallel cuts  $1/16''$  apart. At a  $90^\circ$  angle to the first set of 11 cuts and crossing them, make a second set of 11 parallel cuts, also  $1/16''$  apart (Figure 4d). The purpose of the cuts is to break the film plane of the paint.
3. Pressing firmly, apply a  $1/2''$ -wide strip of strong tape (i.e. Scotch™ brand) across the scored area (Figure 4e).

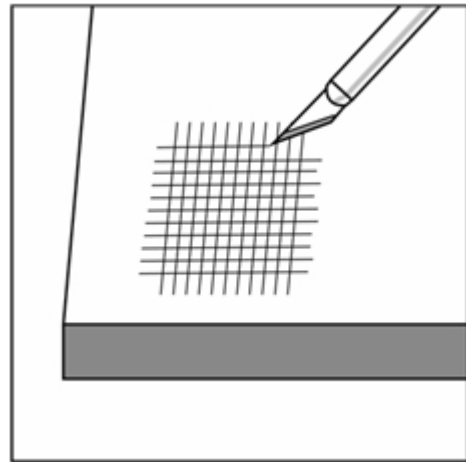

Figure 4d

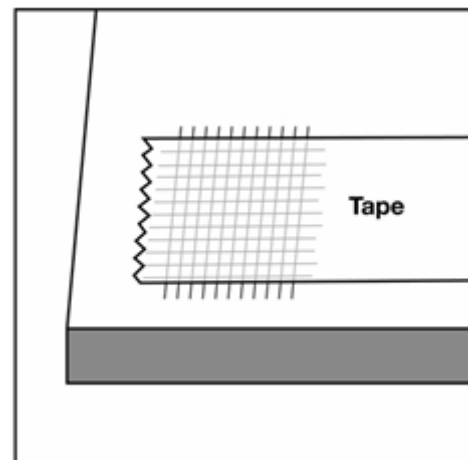

Figure 4e

4. Immediately and in one rapid motion, remove the tape by pulling it back at a 180° angle, parallel to the Celtec sheet (Figure 4f).

5. Proper adhesion has been obtained if paint remains on the Celtec after the tape is removed. Relative paint adhesion comparisons can also be made by inspecting the amount of paint remaining in the area that was covered by the tape.

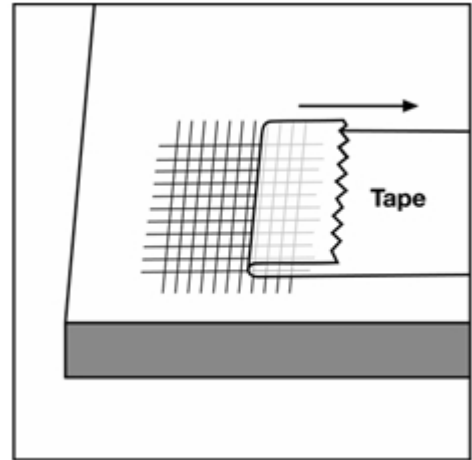

Figure 4f

## Application

Concentrated forms of paints and ink should be thinned before use. Follow the manufacturer's guide and recommendations.

For best results, conventional air spraying equipment can be used on Celtec material (Figure 4g). Paints may also be applied with a paint brush or roller.

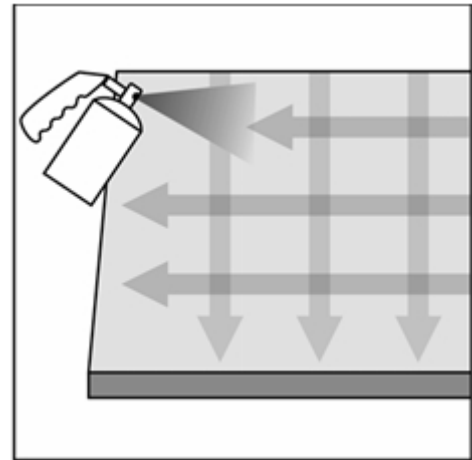

Figure 4g

## Spraying Hints

- Do not use airless spraying equipment. Air-operated equipment, such as DeVilbiss spray finishers, is preferred.
- Use a spray nozzle with a #30 air cap to disperse the paint properly.
- Set the air pressure on the material at 24 psi and 40-50 psi on the air cap.
- Keep the spray gun nozzle perpendicular to the surface of the material
- Make three spraying passes in one direction, turn the panel 90°, and make three additional passes.
- Lightly sand any runs that occur on the edges of the Celtec with 200 grit sandpaper and touch up with additional paint as needed.



# Graphic Applications

CELTEC®



One interesting development that has shown great benefits in painting for outdoor applications is the UV reflective paints available through Blue River Coatings, Sherwin Williams and Reno Coatings. Test data shows that the surface temperatures for the painted material are dramatically decreased, which helps reduce expansion and protects the material, thus creating a longer lasting sign. These UV reflective coatings are especially beneficial when a darker color is needed for a sign or display. Care should be taken to follow the manufacturer’s procedures. Always test a small piece in the precise application before final preparations are made. See the Paint Manufacturers table and Addenda at the end of this chapter for contact information and test data.

## Specifications

### Celtec Digital Flatbed Test Program

Manufacturer	Model Tested	Speed (sq. ft. / hr.)	Resolution	Max Width	Ink Type
Agfa	Anapurna M2050	484	1,440	80"	UV Cure
	Anapurna M2540 FB	575	1,440	80"	UV Cure
Durst Image Technology	Rho 160	500	360	62"	UV Cure
	Rho 800 HS	2000	600	98"	UV Cure
EFI (Vutek)	GS3250	2400	1,000	126.5"	UV Cure
Fuji Film USA	Inca Onset S20	2690	600	63"	UV Cure
	Inca Onset S40	5059	600	63"	UV Cure
Hewlett Packard	Scitex FB500	398	1,200	64"	UV Cure
	Scitex FB700	961	1,200	98.4"	UV Cure
Mimaki	UJV-160	65	1,200	63.7"	UV Cure
Polytype	Swiss Q Impala	2045	1,350	98.4"	UV Cure
	Virtu Abacus 35	1237	1,200	98.4"	UV Cure

## Vinyl Lettering

When applying text to Celtec, pressure-sensitive or static cling vinyl letters are highly recommended. As with other graphic applications, the surface of the Celtec material must be free of dust or other small particles, degreased and dry before applying lettering (Figure 4h).



Figure 4h

## Manufacturers

### Flatbed Printer Manufacturers

Company	Contact	Address
Agfa Graphics <a href="http://www.agfagraphics.com">www.agfagraphics.com</a>	800.540.2432 F: 201.440.6794	611 River Drive, Center 3 Elmwood Park, NJ 04704
Durst Image Technology <a href="http://www.durstus.com">www.durstus.com</a>	585.486.0340 F: 585.486.0350	50 Methodist Hill Drive, Suite 100 Rochester, NY 14623
Electronics For Imaging, Inc. <a href="http://www.efi.com">www.efi.com</a>	650.357.3500 F: 650.357.3907	330 Velocity Way Foster City, CA 94404
Fuji Film USA <a href="http://www.fujifilmusa.com">www.fujifilmusa.com</a>	913.342.4060	1101 W. Cambridge Drive Kansas City, KS 66103
Hewlett Packard <a href="http://www.hp.com">www.hp.com</a>	800.752.0900	300 Hanover Street Palo Alto, CA 94304
Mimaki <a href="http://www.mimakiusa.com">www.mimakiusa.com</a>	888.530.4021	150 Satellite Boulevard NE, Suite A Suwanee, GA 30024
Mutoh America <a href="http://www.mutoh.com">www.mutoh.com</a>	480.968.7772 F: 480.968.7990	2602 South 47th Street, Suite 102 Phoenix, AZ 85034
Oce North America <a href="http://www.oceusa.com">www.oceusa.com</a>	800.714.4427	5450 N. Cumberland Avenue Chicago, IL 60656
Polytype <a href="http://www.wifag-polytype.com/">http://www.wifag-polytype.com/</a>	201.995.1000	10 Industrial Avenue Mahwah, NJ 07430

# Graphic Applications

CELTEC®



## Recommended Silkscreen Inks for Celtec

Manufacturer	Trade Name	Type	Mesh	Squeegee	Additive
FujiFilm	Uviflex	UV Cure	390 LE Twill	70 - 90 D	UX-MX UX-TH
	Fascure	UV Cure	390 LE Twill 390 LE Plain	70 - 90 D	-
	GVYL	Vinyl	230	60 D	80236
	Plastical	UV Cure	390	80 D	-
	VYL	Vinyl	230	60 D	37270
Sun Chemical (Coates Screen)	C99 Series	Vinyl	230	70 D	ET-10
	Series HG	Vinyl	305	55-65 D	HG-V
	Series UVN	UV Cure	305	75 - 85	Call Manufacturer
NazDar	VP	Solvent based	200 - 305	75 - 85	VP-180
	System-2	Solvent based	200 - 305	-	S-230
	2700	Water	200 - 305	-	RE-192
	MP Multi Purpose	Solvent Based	200 - 305	-	MP-180
	9700	Solvent Based	200 - 305	75 - 80	RE-180
	1600	UV Cure	355 - 390	70 - 90	RE-301
	1700	UV Cure	355 - 390	70 - 90	RE-317
	3600	UV Cure	355	70 - 90 D	RE-306

## Silkscreen Ink Manufacturers

Company	Contact	Address
FujiFilm <a href="http://www.fujifilmusa.com">www.fujifilmusa.com</a>	913.342.4060	1101 W. Cambridge Drive Kansas City, KS 66103
NazDar <a href="http://www.nazdar.com">www.nazdar.com</a>	800.677.4657 F: 913.422.2296	8501 Hedge Lane Terrace Shawnee, KS 66227
Sun Chemical (Coates Screen) <a href="http://www.sunchemical.com">www.sunchemical.com</a>	973.404.6000 F: 973.404.6001	35 Waterview Boulevard Parsippany, NY 07054

## Recommended Paints

Manufacturer	Trade Name	Type	Catalyst	Reducer	Primer	Thinner
BASF	Glasuret 21	Acrylic Urethane*	-	-	-	-
Blue River Coatings	Hydro-Flex P-IR	Water Based Urethane	X7000	None	None	Clean Water
	High Perf. A-IR	Acrylic X7000 Urethane	-	None	None	Clean Water
Carbit Paint	Carbithane 11	Acrylic Polyurethane	11C2	T-64	-	-
	Carbithane 12	Acrylic Polyurethane	12C0	T-64	-	-
Matthews	MAP	Acrylic Polyurethane	43-270SP 43-621SP**	45-280SP 25-290SP 6372SP 6396SP	Tie Bond 74 777SP	45-280SP 25-290SP 6372SP 6396SP
	Satin MAP	Acrylic Polyurethane	43-270SP 43-621SP**	45-280SP 25-290SP 6372SP	Tie Bond 74 777SP	45-280SP 25-290SP 6372SP
	VOC MAP	Acrylic Polyurethane	285-800SP	6300SP 6301SP 6302SP	Tie Bond 74 777SP	45-280SP 25-290SP 6372SP
	Satin VOC MAP	Acrylic Polyurethane	285-320SP	6300SP 6301SP 6302SP	Tie Bond 74 777SP	45-280SP 25-290SP 6372SP
One Shot	1 Shot Lettering	Enamel	-	-	1 Shot Primer	-

(continued on next page)

# Graphic Applications

CELTEC®



Manufacturer	Trade Name	Type	Catalyst	Reducer	Primer	Thinner
Samuel Sabot	The Finish, 1700 Series	Acrylic, low luster exterior	-	-	-	-
Sherwin Williams	A-100	Acrylic Latex	-	-	-	-
	Duration	Acrylic Latex	-	-	-	-
	Emerald	Acrylic Latex	-	-	-	-
	Polane E	Polyurethane Enamel***	V66 / V29	R7K388	-	-
	Polane HS Plus	Polyurethane Enamel	V66 / V55	R7K30	-	-
	Polane S Plus	Polyurethane Enamel	V66 / V55	R7K30	-	-
	Polane T 60	Polyurethane Enamel	V66 / V90	R7K84	-	-
	Pro Industrial	Acrylic Latex	-	-	-	-
	Resilience	Acrylic Latex	-	-	-	-
	Solo	Acrylic Latex	-	-	-	-
Spraylat	Lacryl 400	Acrylic Lacquer	-	-	-	205-T 206-T
	Lacryl 800	Acrylic Lacquer	-	-	-	205-T 205-T 208-T
	Polycryl 7000	Acrylic Lacquer	-	-	-	-
	Series 20	Acrylic Lacquer	-	-	-	-
T.J. Ronan	Bulletin Color	Alkyd Enamel	-	-	Prime-All	-
	Aqua Cote	Waterborne Acrylic	-	-	Prime-All	-

\* Requires the use of 521-111 Elastiger Plus Topcoat.

\*\* Requires the use of 47-444SP Brushing-Rolling Additive.

\*\*\* Requires R7KB4 solvent needed.

## Paint Manufacturers

Company	Contact	Address
Akzo Nobel Coatings, Inc. <a href="http://www.akzonobel.com">www.akzonobel.com</a>	610.685.7600	1500 Columbia Street Reading, PA 19610
BASF Corporation <a href="http://www.basf.com">www.basf.com</a>	973.426.2600	100 Park Avenue Florham Park, NJ 07932
Blue River Coatings <a href="http://www.bluerivercoatings.com">www.bluerivercoatings.com</a>	402.463.3962 F: 402.463.4476	2910 S. Nebraska Avenue Hastings, NE 68901
Carbit Paint Company <a href="http://www.carbit.com">www.carbit.com</a>	312.280.2300 F: 312.280.7326	927 West Blackhawk Street Chicago, IL 60642
Hydrocote Finishing Products <a href="http://www.hydrocote.com">www.hydrocote.com</a>	732.828.7448 F: 732.828.7325	P.O. Box 97 Somerset, NJ 08875
Matthews Paint Company (PPG) <a href="http://www.signpaint.com">www.signpaint.com</a>	800.323.6593	One PPG Place Pittsburgh, PA 15272
One Shot, LLC <a href="http://www.1shot.com">www.1shot.com</a>	773.646.2778	1701 East 122nd Street Chicago, IL 60633
Samuel Cabot Paint <a href="http://www.cabotstain.com">www.cabotstain.com</a>	800.877.8246	100 Hale Street Newburyport, MA 01950
Sherwin-Williams <a href="http://www.sherwin-williams.com">www.sherwin-williams.com</a>	800.474.3794	Contact local dealers
Spraylat <a href="http://www.spraylat.com">www.spraylat.com</a>	914.738.1600 F: 914.712.2838	143 Sparks Avenue Pelham, NY 10803
T.J. Ronan Paint Company <a href="http://www.ronanpaints.com">www.ronanpaints.com</a>	718.292.1100 F: 718.282.0406	749 East 135th Street Bronx, NY 10454

# Graphic Applications

CELTEC®



## Manufacturers

### Primer Manufacturers

Company	Contact	Address
Masterchem Industries <a href="http://www.masterchem.com">www.masterchem.com</a>	800.325.3552	3135 Highway M Imperial, MO 63052
One Shot, LLC <a href="http://www.1shot.com">www.1shot.com</a>	773.646.2778	1701 East 122nd Street Chicago, IL 60633
T.J. Ronan Paint Company <a href="http://www.ronanpaints.com">www.ronanpaints.com</a>	718.292.1100 F: 718.282.0406	749 East 135th Street Bronx, NY 10454

### Vinyl Graphics Manufacturers

Company	Contact	Address
3M Commercial Graphics <a href="http://www.3m.com">www.3m.com</a>	800.328.3908	3M Center, Building 0220-12-E-04 St. Paul, MN 55144
Arlon <a href="http://www.arlon.com">www.arlon.com</a>	714.540.2811 F: 800.329.2756	2811 S. Harbor Boulevard Santa Ana, CA 92704
Kapco Graphics <a href="http://www.kapco.com">www.kapco.com</a>	330.678.1626 F: 330.678.3922	1000 Cherry Street Kent, OH 44240
ORACAL USA <a href="http://www.oracal.com">www.oracal.com</a>	914.851.5000 F: 914.851.5050	1100 Oracal Parkway Black Creek, GA 31308

## Addenda

### Test Data for UV Reflective Coatings

Three pieces of 1-1/2" Celtec Foam PVC were cleaned and coated with Prolux Series 32000 brown paint. After 30 minutes of air-drying, the pieces underwent two hours of forced drying at 110°F.

After 10 days the three samples were tested for adhesion and showed complete adhesion of the paint to the substrate.

The pieces were also tested for resistance to heat buildup, using a 250-watt infrared lamp. The samples were placed under the lamp, with the painted surface facing the lamp at a distance of 13 inches. After one hour, the maximum temperature reached by the surface was 160°F (hottest spot) measure with an IR gun. The three samples performed very well, with no change or deterioration at the surface, no blistering of the paint and no deformation of the substrate.

A similar high-quality brown paint (but with no heat-reflective properties) was applied to the other side of the samples. Upon performing the same heat exposure test, the hottest spot reached 230°F, and there was a slight deformation of the surface at that area.

### Test Data for Blue River Coatings Hydro-Flex PIR

Celtec samples were cleaned with Hurrifsafe Paint Prep (PCI Corp: 301-320-9100) to remove any residual dirt and oils from handling. The samples were then sprayed coated with Blue River Coatings Hydro-Flex PIR, a heat reflective paint. Black and forest greens colors were chosen since these colors would typically see the most heat gain in an outdoor environment. The Hydro-Flex samples were compared to a similar sample using standard black paint.

After 48 hours, the samples were first tested for adhesion using a standard cross hatch test and then tested for impact adhesion using an impact machine. The Hydro-Flex samples passed the cross hatch test and the impact adhesion test at 88, 120 and 80 psi respectively.

For the heat gain tests, a standard IR lamp was used to introduce heat, and the heat gun was measured on the back side of the Celtec sheet. The largest difference in heat gain was seen between the black samples coated with standard Paint verses Hydro-Flex, where there was a 30°F difference in heat gain.



## 5

Celtec's light weight, strength and versatility allow it to be used in many special applications. Celtec is an effective core material for panel constructions using common synthetic resins or a wide variety of structural adhesives or plastics. Celtec's smooth surface and adherence capacity make it an excellent choice for photomounting and laminating, whether by hand for small jobs or with automated equipment for larger production runs.

### Photomounting

Celtec offers an excellent surface for mounting numerous materials, including Cibachrome prints, lithographs, blueprints, tissues and nearly all types of other papers (Figure 5a). Because of its strength and rigidity, a stronger finished product is produced using Celtec as compared to others available substrate materials. For example, the corners of Celtec photomounting application will not bend or crease, as wall items mounted on cardboard or foam-type materials.



Figure 5a

One significant advantage of photomounting is Celtec's smooth finish relative to other thermoplastics. This finish allows prints to be easily repositioned or other mounted materials to be removed when necessary.

Once the mounting process is complete, Celtec can be laminated and then routed, heat bent, drilled, silk screened or painted for use in virtually any display application.

The preferred methods of photomounting on Celtec sheets are:

- Cold mounting using cold roller laminators, such as Warman-Greig, Greig or Sealeze presses.
- Cold vacuum mounting with VacuSEAL presses.
- Hand laminating.

The sophisticated Greig press is used by large photo labs, while the Sealeze press is more commonly found at small commercial labs. The VacuSEAL press is utilized primarily by photo shops.

**NOTE!** Because Celtec material may warp when heated above 140°F or when heated from one side only, it cannot be dry mounted or hot mounted.

### Laminating

Celtec is an ideal material for applications that require lamination. This section provides preparation information process as well as detail instructions for various types of lamination that can be used with Celtec.

Because prints are one of the most frequently laminated materials, the sections that follow will generally refer the lamination of a print, although many other materials can be used.

**NOTE!** Because Celtec material may warp when heated above 140°F or when heated from one side only, it cannot be used in any lamination process requiring heat.

### Adhesion

For best results, the Celtec material should be cleaned with isopropyl alcohol prior to adhesion and allowed to dry thoroughly.

When laminating with pressure-sensitive adhesives, a force of 25-40 psi is required (Figure 5b). Proper spacers are also critical. Because force must be applied equally across the material, the top roll must move evenly from left to right while maintaining even contact between top and bottom laminating rolls.

To achieve even contact, “zero the nip,” then use spacer shims to preset the nip opening for a particular laminate. Use sufficient pressure to completely eliminate any air bubbles between the Celtec material, the adhesive and the print or other material.

Figure 5b

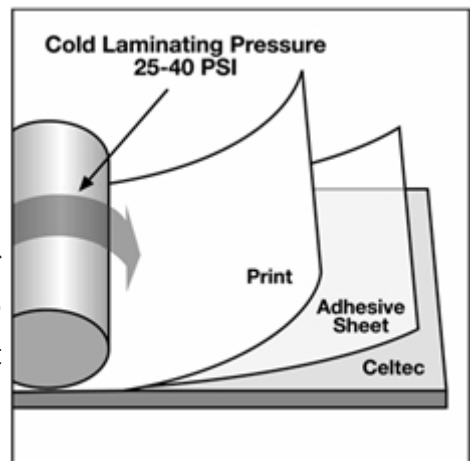

# Special Applications

CELTEC®

The lamination will achieve maximum bonding in three hours. If the lamination has been performed properly, the finished mount can be flexed without the print becoming loose in the center.

To prevent moisture from becoming trapped between layers of porous material (such as paper) and creating blisters, the level of moisture in both the material to be laminated and the atmosphere should be reduced before pressing. Some materials may require pre-drying. Celtec is nonporous and does not need pre-drying.

**NOTE!**

Avoid hanging tacked pieces upside down for longer than 10 minutes as the prints may absorb moisture and change in dimension, causing bubbles and wrinkles in the finished product.

## Preventing Surface Blemishes

Surface blemished, such as wrinkles, can be caused by misalignment of the adhesive roll, too much pressure or rollers that are not parallel. Trapped dirt or lumps of hardened adhesive common with Cibachrome or glossy prints may create small bumps in the finished product.

In order to prevent these problems, equipment used for Celtec lamination must be kept clean (Figure 5c). Use a fresh roll or sheet of transfer adhesive if bumps are caused by hardened adhesive. Dirt problems can be minimized by using an ionizing static eliminator.

Using prints or other materials made with a paper 0.007" or thicker can help prevent strike through.

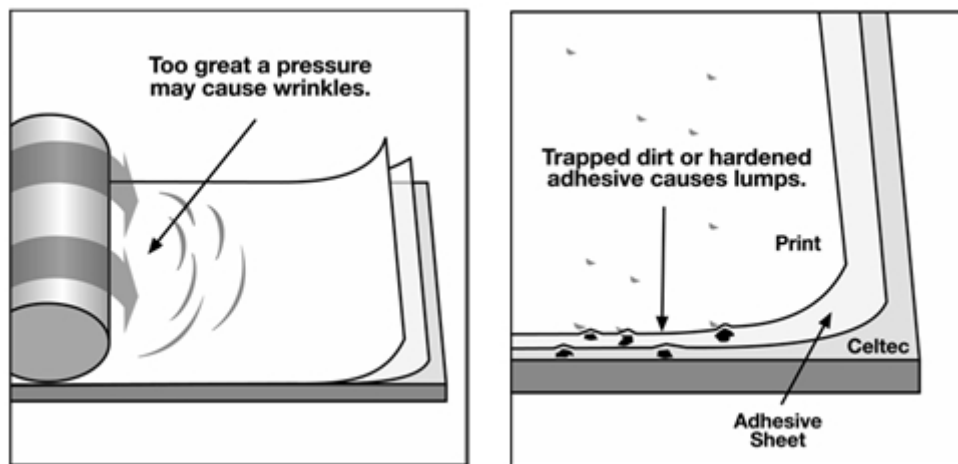

Figure 5c

**TIP!**

For best results, wipe down the back of the print and the face of the Celtec mount with a clean, dry cloth before it passes through the roll nip.

Whether the finished product is to be used indoors or outdoors, a clear, high gloss overlay will help protect against fading as well as enhance the color. MACtac IP 7000 Perma Color overlay and Seal Print Shield have proven to work effectively with Celtec.

**NOTE!**

Do not use overlays, clear coatings or sprays that contain solvents, as they may cause blistering.

## Laminating Techniques

Four techniques are recommended for laminating materials to Celtec, as described in the following sections. Depending upon the type of process applications and the equipment available, one or more of these processes may be appropriate for a particular application. None of these processes involves the use of heat. Because Celtec may warp at temperatures above 140°F or when heated from one side only, it cannot be dry mounted or hot mounted.

The four recommended lamination techniques for Celtec are:

- Cold laminating with a press, using adhesive-backed paper.
- Cold laminating using Vac-U-Mount press.
- Hand laminating using transfer adhesive.
- Hand laminating using spray adhesive.

### Cold Laminating with a Press using Adhesive-backed Paper

This process is most frequently used by commercial photo labs with Greig or Sealeze presses and transfer adhesives, such as MACtac IP 2000, Photomount or Seal Print Mount. Either of two types of liner films, as a single release liner film or a double release liner film, can be used for this process. The basic process for laminating with a press using adhesive-backed paper is described in the following section.

# Special Applications

CELTEC®



CELTEC  
GRAPHIC & DISPLAY  
MATERIALS

1. Set the roller pressure properly for the thickness of the pre-coated mounting substrate.
2. Place the mounting substrate on a flat surface and expose approximately one inch of the adhesive by peeling back the release paper (Figure 5d).
3. Carefully position the print on top of the substrate, using the folded release paper to prevent contact with the exposed adhesive (Figure 5e). Once positioned correctly, carefully apply the print to the exposed adhesive, pressing from the center toward the edges to ensure a smooth tack.

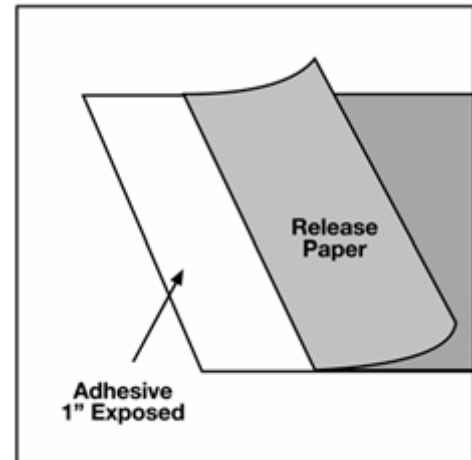

Figure 5d

4. Place the direction switch in the forward position and the speed control on medium.
5. Insert the materials to be processed into the laminator opening. Depress the foot switch and feed the substrate between the rollers until the pressure roller rests on the tacked portion of the material.
6. Hold the un-tacked portion of the print up and against the pressure roller. Depress the foot switch to feed the substrate through the rollers while peeling the release paper off the mounting substrate with one hand. To prevent wrinkles, the print must be held against the roller with the opposite hand while the substrate feeds through the press.

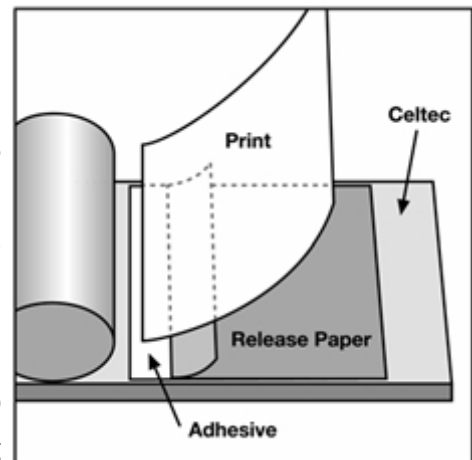

Figure 5e

7. Remove the mounted print from the rear of the laminator and trim it to the required size.

## Coating using Single Release Liner Films

1. Set the pressure properly for the thickness of the substrate (s) to be processed.
2. Load the supply roll of pressure-sensitive adhesive, such as Sealeze Print Mount.
3. Pull approximately 12 inches of adhesive film forward off the roll. Rest the film, adhesive side up, on top of the pressure roller.

4. Create a leader board by cutting a piece of substrate slightly larger than the width of the adhesive film and approximately four to six inches long. Lay the leader board across the film and smoothly adhere the bottom of the leader to the adhesive.
5. Place the direction switch in the forward position and the speed control on medium.
6. Pull the leader down and push it between the rollers. Depress the foot switch and feed the leader between the rollers approximately three to four inches. Be sure that the adhesive stays firmly adhered to the leader.
7. Once this process has been completed (referred to as “stringing the web”) and the adhesive is feeding without wrinkles, the laminator is ready for production.
8. To coat, feed a substrate behind the leader board and between the rollers while depressing the foot switch. Feed until the substrate exits the rollers and automatically stops feeding. At this time, another substrate may be fed between the rollers for coating. This process is suitable for films with a paper release liner, such as Sealeze Print Mount and leaves a 3/8” to 1/2” gap between the coated substrates to facilitate the trimming process.
9. After exiting the laminator, the coated substrate should be split apart and trimmed (Figure 5f).

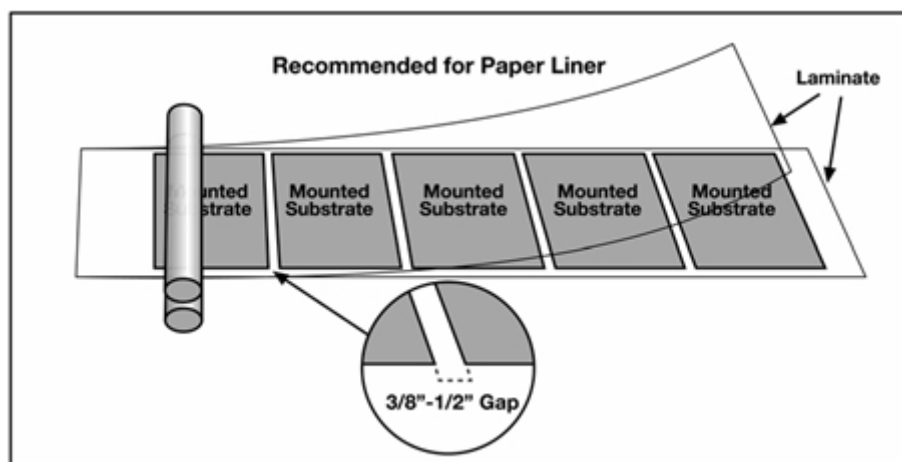

Figure 5f

### Coating using Double Release Liner Films

Coating with double release liner film, such as Sealeze OptiMount-UV or Print Mount Double, requires the use of a take-up mechanism to automatically remove and rewind one of the release liners during the coating procedure.

# Special Applications

CELTEC®



CELTEC  
GRAPHIC & DISPLAY  
MATERIALS

1. Set the pressure properly for the thickness of the substrates to be processed.
2. Load the supply roll of pressure-sensitive adhesive, such as Sealeze OptiMount-UV.
3. Adhere double-stick tape or a pressure-sensitive film, such as Sealeze OptiMount-UV or Print Mount Double, to the surface of the take-up shaft.
4. Pull approximately 18" inches of adhesive film forward off the roll and adhere one release liner side smoothly to the take-up shaft, taking care to ensure that the film is square with the supply roll and no diagonal wrinkles are apparent (Figure 5g).

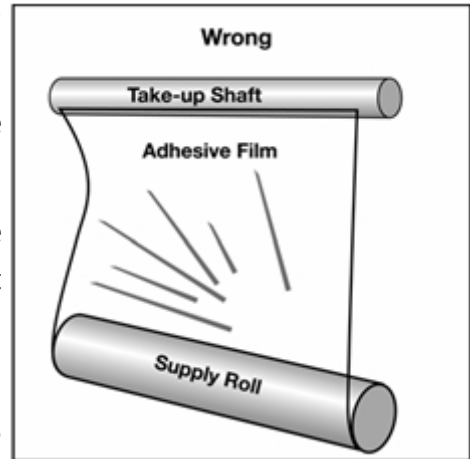

Figure 5g

5. Separate the adhesive film from the release liner secure to the take-up shaft and pull the adhesive film and remaining release liner down so that it rests adhesive side up on top of the pressure roller.
6. Lay a leader board the same thickness as the substrates to be used across the exposed adhesive film and smoothly adhere the bottom of the leader to the adhesive.

## Cold Laminating with VacuSEAL Press

This method is suggested for small and medium-sized photo shops for mounting prints utilizing a spray adhesive, such as 3M Vac-U-Mount.

1. Spray the adhesive on the back of the piece to be mounted, keeping the spray six to eight inches from the surface. If using a double coat of adhesive, the second coat should be applied in a direction perpendicular to the first coat. For bonding most art materials, the adhesive is typically applied only to one surface, usually the back of the print.
2. Allow the spray to dry two to four minutes before mounting so that the adhesive becomes tacky. If blisters occur from trapped solvent, allow the adhesive to dry slightly longer than four minutes.
3. Position the print on the Celtec material and place inside the VacuSEAL vacuum frame.
4. Apply vacuum for 10 minutes.

## Hand Laminating using Transfer Adhesive

For small shops or displays makers without access to presses, this method can be used for lamination of flat, relatively small items utilizing a transfer adhesive (Figure 5h).

1. Using a sheet of transfer adhesive having both sides covered by release paper, peel away and fold back the release paper 1/2" inch from one edge.

2. Place the edge of the print to be laminated on the exposed adhesive.

3. Remove the rest of the release paper while lifting the print slightly to avoid contact with the adhesive, then use a roller or a squeegee to smooth the print evenly onto the adhesive.

4. With the face print down and the remaining release paper facing up, smooth out any excess air from between the print and the adhesive with a squeegee.

5. To laminate the print to the Celtec material, peel away and fold back the release paper 1/2" from one edge.

6. Placing the print evenly on the Celtec material, tack the exposed adhesive to the Celtec.

7. Gradually remove the liner while pressing closely with a had roller or a squeegee to eliminate any air bubbles until the entire print has been laminated (Figure 5i).

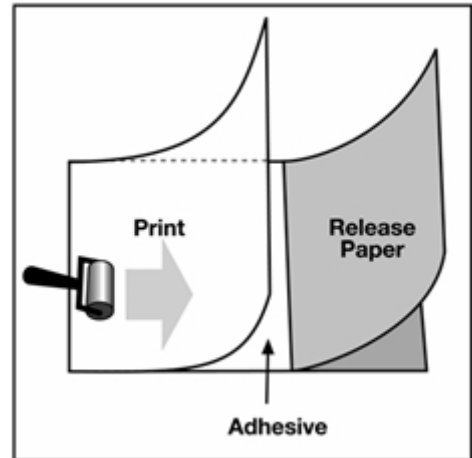

Figure 5h

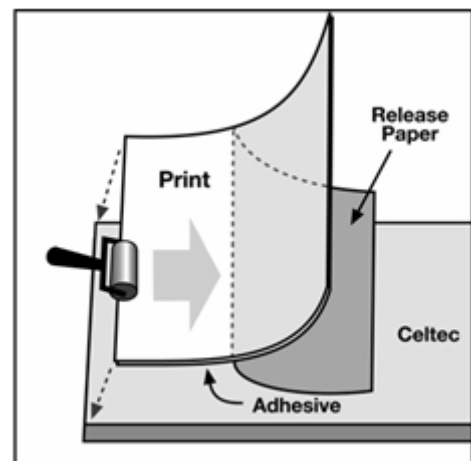

Figure 5i

**TIP!**

For best results, remove only a small section of the liner at a time, approximately 12" or less, while adhering the print to the Celtec.



## Hand Laminating using Spray Adhesive

For small shops or display makers without access to equipment, this method is recommended for the lamination of flat, relatively small items utilizing a spray adhesive, such as 3M Vac-U-Mount (Figure 5j).

Figure 5j

1. Spray the adhesive on the back of the piece to be mounted, keeping the spray six to eight inches from the surface. It using a double coat of adhesive, the second coat should be applied in a direction perpendicular to the first coat. For bonding most art materials, the adhesive is typically applied only to one surface, preferably the back of the print.

2. Allow the spray to dry between two to four minutes before mounting so that the adhesive becomes tacky.

3. Place the adhesive side of the print or other item on the Celtec surface, pressing smoothly from the center of the piece to the edges in order to eliminate any wrinkles and trapped air immediately.

4. Place a clean sheet of Celtec over the laminated piece to weigh it down. Although the bond should be at a maximum strength after fifteen minutes, allow 24 hours before exposing the piece to any sudden temperature or humidity changes.

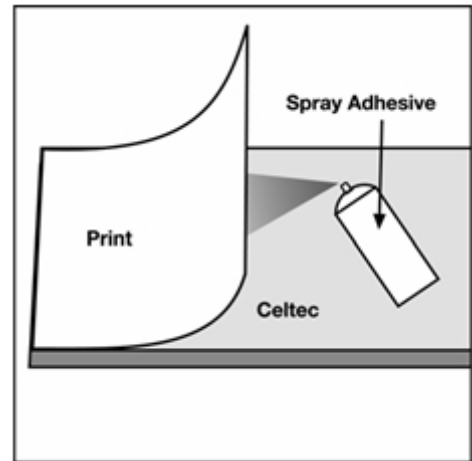

## Delaminating

A print mount can be delaminated within five minutes if a pressure-sensitive adhesive, such as MACtac IP 2000 or Seat Print Mount, has been used. Although the print is usually ruined, the Celtec material can be reused.

If five minutes have already passed, a hot air gun or a hair dryer can be used to heat the material in order to peel off the lamination. Isopropyl alcohol or mineral spirits can be used to remove the remaining adhesive.

## Manufacturers

Company	Contact	Address
3M Adhesives Division <a href="http://www.3m.com">www.3m.com</a>	800.362.3550 F: 651.733.9175	3M Center, Building 21 St. Paul, MN 55144
DryTac Corporation <a href="http://www.drytac.com">www.drytac.com</a>	800.280.6013	5601 Eastport Boulevard Richmond, VA 23231
Henkel Adhesives <a href="http://www.henkel.com">www.henkel.com</a>	847.468.9200 F: 847.468.9819	1345 Gasket Drive Elgin, IL 60120
MACTac <a href="http://www.mactac.com">www.mactac.com</a>	866.262.2722	4560 Darrow Road Stow, OH 44224

## Photomounting Press Manufacturers

Company	Contact	Address
Advanced Greig Laminators <a href="http://www.aglinc.com">www.aglinc.com</a>	800.276.2664	801 Burton Boulevard DeForest, WI 53532
Seal Graphics America <a href="http://www.sealgraphics.com">www.sealgraphics.com</a>	800.257.7325 F: 800.966.4554	7091 Troy Hill Drive Elkridge, MD 21075

## Cold Mounting Laminator Manufacturers

Company	Contact	Address
Coda, Inc. <a href="http://www.codamount.com">www.codamount.com</a>	201.825.7400 F: 201.825.8133	30 Industrial Avenue Mahwah, NJ 07430

# 6

Field performance of Celtec indicates excellent weatherability in outdoor applications under various environmental conditions.

## Weatherability / Effects of Outdoor Exposure

### Tensile Strength

Virtually no tensile strength change have been noted in prolonged environmental exposure tests.

### Color

Dark colors are not recommended because they absorb heat energy and can exceed use temperatures.

### UV Stability of White Celtec

One of the many advantages of Celtec expanded PVC sheet is its ultraviolet durability. Celtec is made from the same ingredients found in most weatherable vinyl siding and window material. While the concentration of these ingredients is not the same, Celtec will provide years of minimal color change. In addition, Celtec will not warp, rot, crack or peel like wood products in similar outdoor exposures.

Celtec was weathered in a “QUV” weatherometer by Vista Chemical Company along with a standard pipe compound, vinyl siding and another major expanded PVC brand. The test replicated two years of exposure outdoors in Arizona. Celtec in 3mm and 6mm thickness retained more of their respective color than did the major competitors’ brands of expanded PVC sheet for the same thicknesses.

### Stress

Some silkscreen inks contain solvents that can cause environmental stress cracks. For more information, refer to the desired manufacturer’s ink and solvent charts.

## Fire Characteristics

Any material having an oxygen index in excess of 26% will not continue to burn when a flame source is removed. The oxygen index of Celtec is 35%, which makes it self-extinguishing, meaning what when the flame source is removed, the burning stops. It is important to remember that many other plastic materials and natural products, such as wood, have values under 26%.

High oxygen index - ASTM D-2863 measures the percent of oxygen in an oxygen / nitrogen mixture that barely supports burning. The oxygen content of the earth's atmosphere is about 21%. Materials with oxygen index values of approximately 28% and above should not continue burning after the flame source is removed because the normal atmospheric oxygen content is insufficient to support combustion.

## Impact Resistance and Environmental Stress

Effect of Temperature - With decreasing temperature, there is a tendency towards decreased impact resistance.

Samples of 3mm Celtec were conducted in a freezer to a temperature of -10°C for a period of twelve hours. The test bars were then impacted per ASTM D266 Charpy Impact - Test Method B (Specimens Un-notched). The "Cold Break" specimens retained 85% of the original room temperature impact strength.

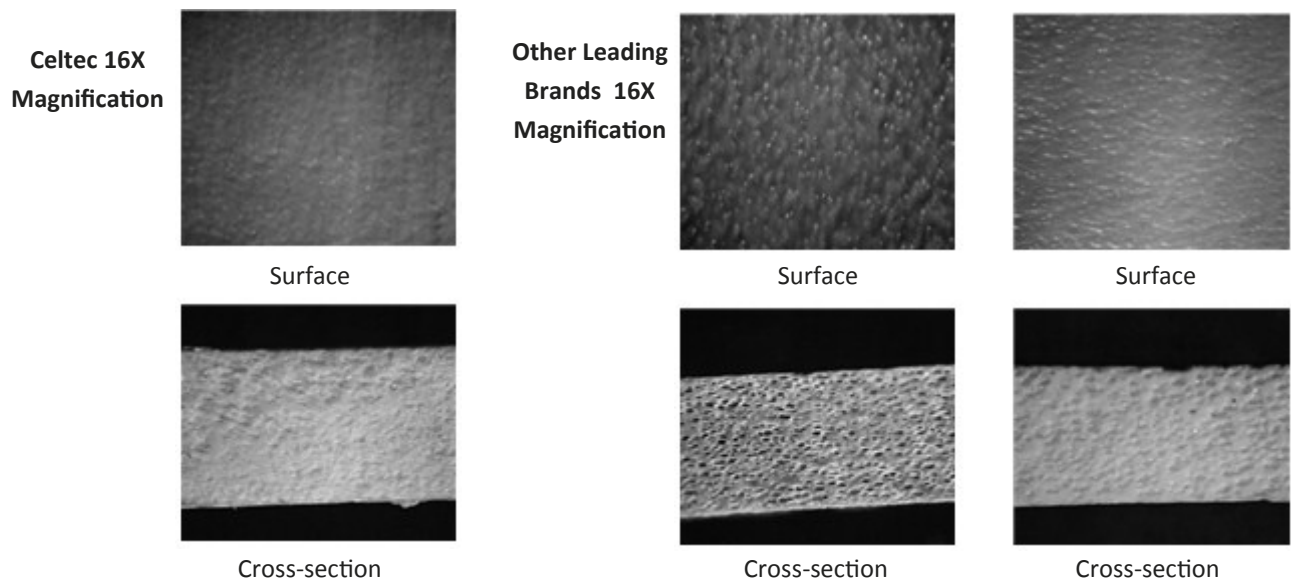

## Cellular Foamed Vinyls

“There are two types of cellular foamed vinyls: open cell and closed cell. In the closed cell type, each cell is individual, usually spherical in shape, and completely enclosed by plastic walls. This type of cell structure has good insulating properties as well as a high degree of buoyancy. In the open cell type, all cells are interconnected. This type of cell structure is known for its absorbency and capillary action.”

Source: Encyclopedia of PVC; Vol. 2, Page 619.

A rigid foam PVC sheet or profile that is extruded via a free expansion process would thus be considered a closed cell foam. Examples of open cell types would be a foamable Plastisol or a sponge-like flexible plastic foam as is used in cushions or padding for furniture.

## Standard Specifications

### USDA Approved - Incidental Contact

Celtec can be used for sign needs wherever food is processed or sold. It is lead-, cadmium- and barium-free.

### U.L. Classified

Celtec is the first foamed PVC to be U.L. Classified, meeting all three U.L. 1975 fire test requirements.

### Fire Characteristics

The oxygen index value of Celtec is 35% materials with a value of 28% or higher are considered self-extinguishing. For comparison, oak carries a value of 23% and birch carries a value of 21%.

### Health and Environmental

Celtec contains no lead, cadmium, barium or zinc heat stabilizers. Celtec is made only with tin, which means that there are no special health, environmental or waste disposal problems.

## ROHS

### **Celtec is RoHS compliant.**

RoHS is the acronym for Restriction of Hazardous Substances. RoHS, also known as Directive 2002/95/EC, originated in the European Union and restricts the use of specific hazardous materials found in electrical and electronic products. All applicable products in the EU market after **July 1, 2006** must pass RoHS compliance.

The substances banned under RoHS are lead (Pb), mercury (Hg), cadmium (Cd), hexavalent chromium (CrVI), polybrominated biphenyls (PBB) and polybrominated diphenyl ethers (PBDE).

The restricted materials are hazardous to the environment and pollute landfills, and are dangerous in terms of occupational exposure during manufacturing and recycling.

# Engineering Specifications



CELTEC®

## Specifications for Celtec Foam PVC Sheet

### Typical Physical Properties

Property	Units	ASTM Method	Celtec 1MM - 30MM	Ultra White
<b>Physical</b>				
Density	g/cm <sup>3</sup>	D 792	0.55 - 0.7	1.42
Absorption	%	D 570 / D 2842	0.15 - 0.3, 0.9	0.06
Hardness, Shore D	Shore	D 2240	-	89
Rockwell Hardness	R Scale	D 785	-	115
<b>Mechanical</b>				
Tensile Strength @ Yield	psi	D 638	2,256 - 3,000	411,000
Tensile Modulus	psi	D 638	144,000 - 232,000	-
Flexural Strength	psi	D 790	3,755	-
Yield Strength	psi	D 790	-	7,500
Flexural Modulus	psi	D 790	170,000	481,000
Yield Strength	psi	D 790	-	12,800
Notched Izod Impact	ft-lb/in.	D 256	0.53	1
Nail Hold	lb./in.	D 1761	35	-
Screw Hold	lb./in.	D 1761	680	-
Staple Hold	lb./in.	D 1761	180	-
Gardner Impact	in/lbs.	D 4228	103	-
Charpy Impact (un-notched @ 23°)	ft-lb/in.	D 256	4.5 - 8.1	-
<b>Thermal</b>				
Vicat Softening Point	°C	D 1525	-	83 / 181
Heat Deflection Temp @ 66 psi	°C	D 648	-	82 / 179
Heat Deflection Temp @ 264 psi	°C / °F	D 648	150	80 / 176
Coefficient of Linear Expansion	in.in. °C	D 696	-	5.8 x 10 <sup>-5</sup>
Coefficient of Linear Expansion	in./in. °F	D 696	3.2-4 x 10 <sup>-5</sup>	3.2 x 10 <sup>-5</sup>
Thermal Conductivity	W/mK	D 177	0.084	-

Property	Units	ASTM Method	Celtec 1MM - 30MM	Ultra White
<b>Flammability Ratings</b>				
Burning Rate	in/min	-	No burn when flame removed	-
Flame Spread Index	-	E 84	20	15
Vertical Burn Test	-	UL 94	5-V	V-0
Flammability	-	D 635	-	Self Extinguishing
Foam Fire Test	-	UL 1975	Passed / Classified	-
Oil Canning (@ 140°)	°F	D 149	Passed	-
<b>Electrical</b>				
Electrical Volume Resistivity	Ohm / cm	D 257	-	5.4 x 10 <sup>15</sup>
Dielectric Constant (60 Hz)	-	D 150	-	3.19
Dissipation Factor (60Hz)	-	D 150	-	0.0096
Loss Index (60 Hz)	-	D 150	-	0.03
Dielectric Strength	volt / mil	D 149	112,000	544
<b>Chemical</b>				
Chemical Resistance	-	D 1784	-	<b>Class B</b>

Physical properties of plastic sheeting are represented as “Typical”. Information contained herein is considered accurate to the best of our knowledge. It is offered for your consideration and investigation, and is not to be construed as a representation or warranty expressed or implied. Our warranties are limited to those expressly stated in formal contracts or in conditions of sale on our invoices and order acceptances. Conditions and methods of use may vary and are beyond the control of Vycom, therefore, Vycom disclaims any liability incurred as a result of the use of this product in accordance with the data contained in our physical property charts. No information herein shall be construed as an offer of indemnity for infringement or as a recommendation to use the products in such a manner as to infringe any patent, domestic or foreign.

The “Typical” properties of our plastic sheet cannot be automatically used when engineering finished components: and the fabricator or end user is responsible for insuring the suitability of our products for their specific application or end use!



## Material Safety Data

Please visit Vycom's website for the following data: [Material Safety Data](#)

1. Product Identification
2. Components and Hazard Classifications
3. Physical Data
4. Fire and Explosion Data
5. Health Hazard Information
6. Reactivity Data
7. Spill or Leak Procedures
8. Special Protection Information
9. Shipping, Transfer and Storage

## Marketing Communication

Please visit Vycom's website for the following information: [Marketing Data](#)

1. Advertising
2. Images
3. Instructional Videos
4. Trade Show Information
5. Sell Sheet
6. Celtec Digital Print Guide

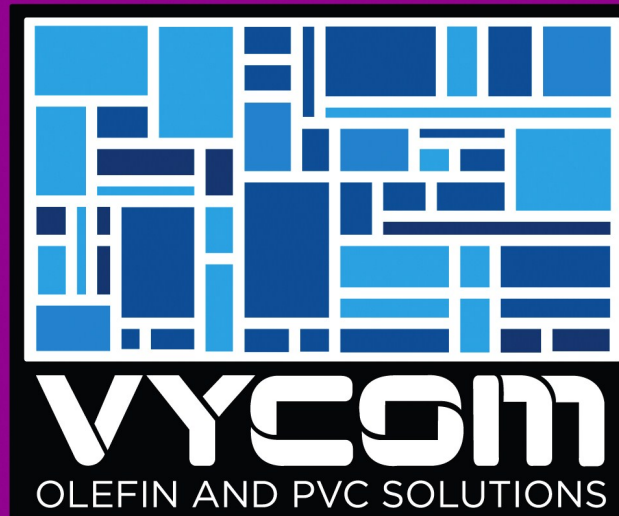

For more than a quarter of a century, Vycom has led the Olefin and PVC sheet products industry with innovative materials for a wide variety of uses. We strive to be the essential partner in creating and implementing solutions in Olefin and PVC polymers that optimize quality and performance. Vycom offers the largest range of products, capabilities, and inventory for all your Olefin and PVC needs.

**WHERE QUALITY  
MEETS PERFORMANCE**

**801 E. Corey Street, Scranton, PA 18505**  
**Phone: (800) 235-8320 • Fax: (800) 858-9266**  
**[www.vycomplastics.com](http://www.vycomplastics.com)**