



# SUNTUF<sup>®</sup> Plus

Greenhouse Applications



## SUNTUF® Plus Greenhouse Applications

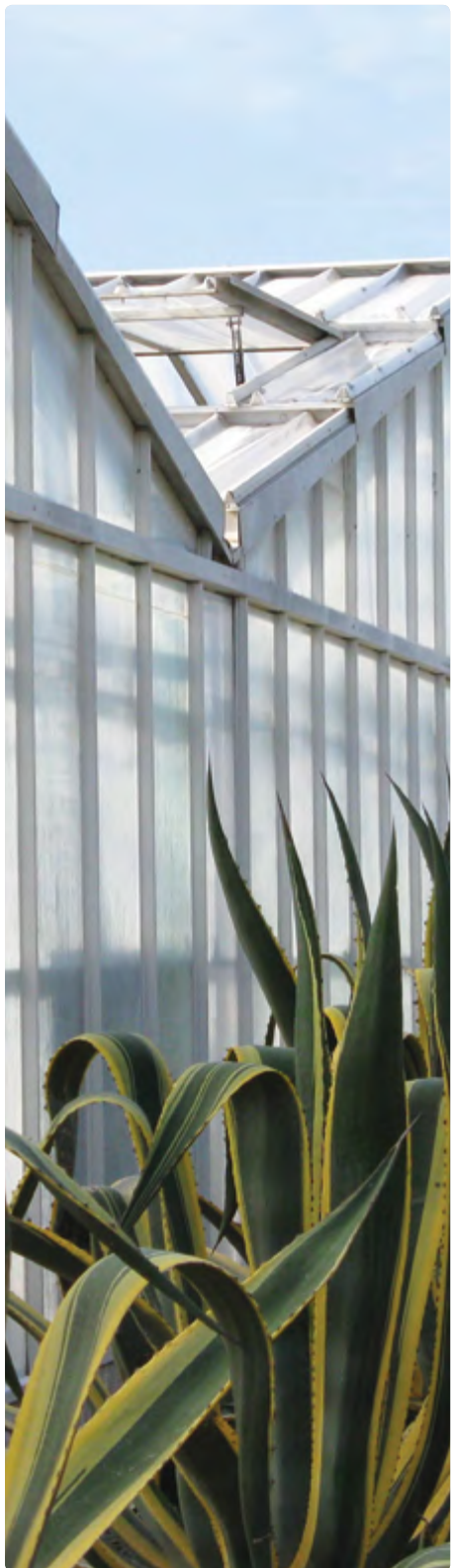

The  
sky  
is  
the  
Limit

## Content

Introduction	2
SUNTUF® Plus Main Benefits	4
SUNTUF® Plus Product Range	6
SUNTUF® Plus for Every plant or crop	6
Guaranteed Condensation Control (Anti-Fog)	7
Project Gallery	8
SUNTUF® Plus Standard Profiles	14
SUNTUF® Plus Custom Made Profile - Glass Replacement Case Study	14



## Introduction

SUNTUF Plus provide the best nurturing conditions possible for plants and workers. It was the first corrugated polycarbonate sheet introduced to the commercial greenhouse market with proven results over twenty years ago. Since then, SUNTUF Plus has become an industry standard which all other corrugated polycarbonate products for the agricultural market are compared to. The SUNTUF Plus product range includes various types and features, which were specifically designed for commercial greenhouse roofing.









## SUNTUF® Plus Main Benefits



### Clarity and Condensation Control

Natural, clear SUNTUF sheet exhibits the clarity of glass, transmitting up to 90% of natural PAR light. SUNTUF Plus also prevents condensation drip and its related drawbacks due to an integrated feature that helps maintain its high light transmission.

### Impact Strength

Manufactured from polycarbonate, SUNTUF is virtually unbreakable and is extremely resistant to impact, hailstones and loads.

### Low Weight

Light in weight, SUNTUF sheets are easy to handle and install.

### Weather Resistance

SUNTUF resist wind, hail and extreme temperatures from -50°C to +120°C. An integrated UV protective layer allows SUNTUF to retain its transparency without yellowing over the course of a long lifetime of service.

### 10 Year Warranty

SUNTUF is warranted to retain its attractive appearance over its long lifetime with minimum maintenance.

### Protection

SUNTUF does not allow harmful UV radiation to penetrate, and meets the highest flammability standards in its field.

## SUNTUF® Plus Product Range

Product	Description
SUNTUF® Plus	Corrugated polycarbonate sheet with integrated UV protective layer on the exterior side and anti-condensation treatment applied to the interior side.
SUNTUF® Plus UV2	Corrugated polycarbonate sheet with integrated UV protective layer on both sides and anti-condensation treatment applied to the interior side.
SUNTUF® Plus Embossed*	Corrugated polycarbonate sheet that exhibit 20% diffusion of the light.
SUNTUF® Plus Diffused*	Corrugated polycarbonate sheet that transmits a selected 85% of the light energy while exhibiting 100% diffusion of the light.

\*Also available with co-extruded UV protective layer on both sides.

### Clear or Diffused: SUNTUF® Plus for Every Plant or Crop

#### Clear

Optimum for low light regions or where high clarity is essential



90% light transmission  
0% Diffusion



#### Embossed

Offers high light transmission and good diffusion for excellent flexibility



90% light transmission  
20% Diffusion



#### Diffuser

Combines even light spread with high light transmission



85% light transmission  
100% Diffusion





## Better Light Transmission than Flat Panel Glazing

In the critical hours of early morning and late afternoon SUNTUF Plus' corrugated shape allows better light transmission than flat glazing such as glass panels, as indicated below.

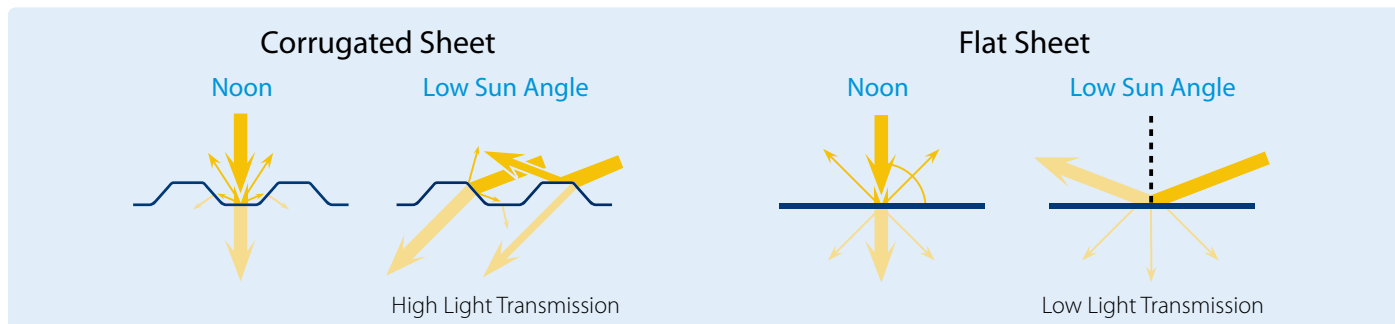

## Guaranteed Condensation Control (Anti-Fog)

SUNTUF Plus, with its unique built-in condensation control, allows up to 30% more light transmission during peak condensation periods. SUNTUF Plus also reduces disease resulting from condensation dripping. For greenhouses with retractable roofs, SUNTUF Plus is offered with anti-condensation treatment on both sides.

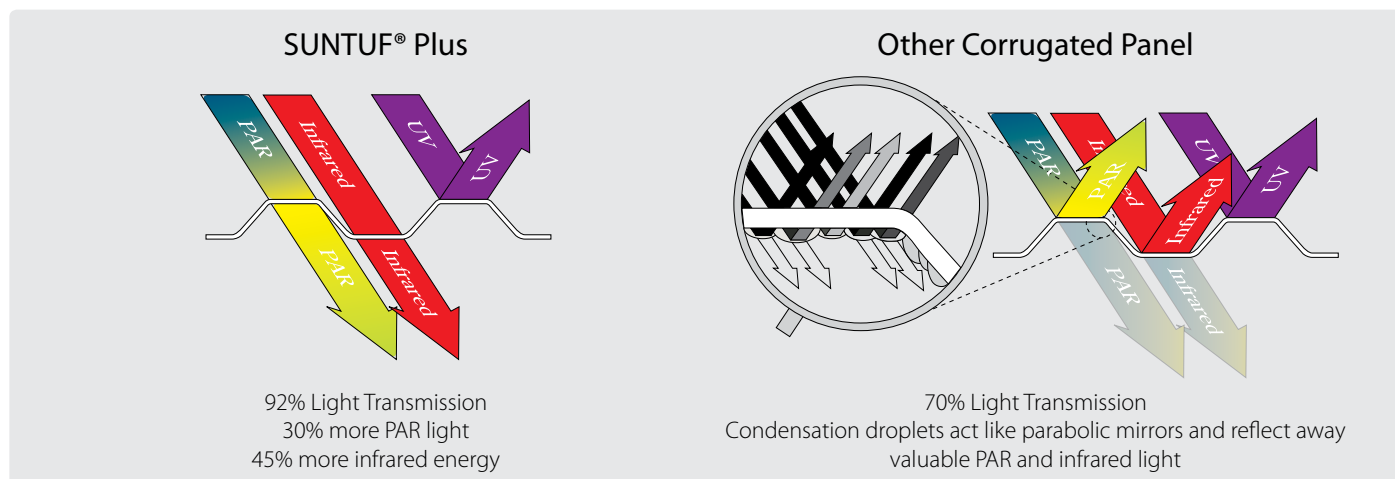

SUNTUF® Plus with guaranteed condensation control.

Alternative roofing product laden with thousands of light-reflecting condensate droplets on the underside of the panel.

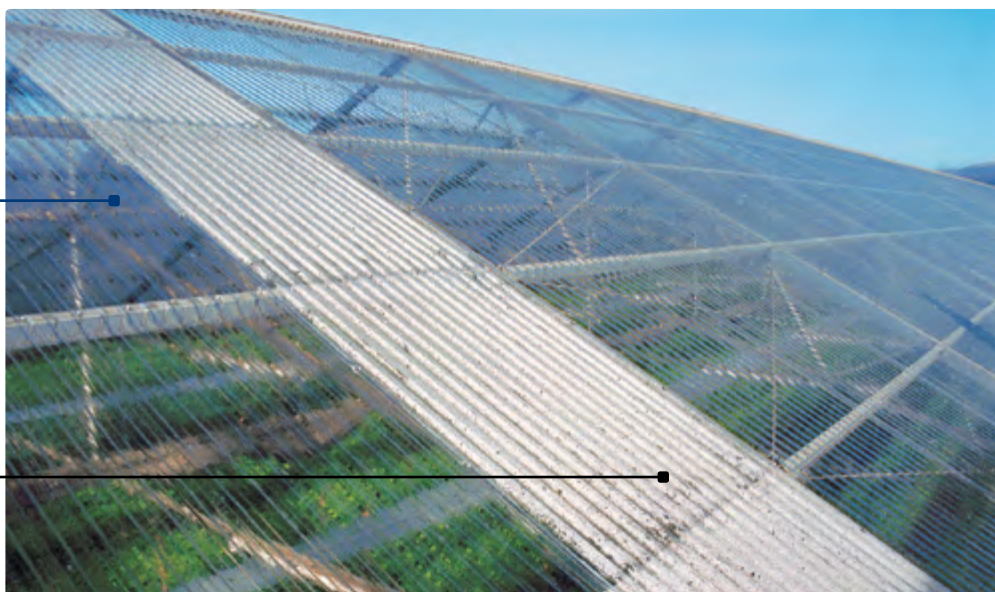



## Project Gallery

Over a million square meters of SUNTUF Plus sheets have been installed during the past 25 years in numerous projects around the globe. A few of them are presented in the following pages.



Double sloped roof and walls - Southern Italy





Arched Roof Roof Greenhouse - USA



Arched Roof - China



## Project Gallery (Continued)



Arched roof Vegetable Greenhouse - Negev (Israeli Desert)



Arched roof ,Garden Center - Israel





Gothic Roof Greenhouse - China



Arched Roof Greenhouse - Antalya, Turkey

## Project Gallery (Continued)



### Xinjiang, western China

No snow accumulation on the SUNTUF roof enables more daylight in the greenhouse





**Xinjiang, western China**

Quick, safe and easy installation of SUNTUF Plus sheets.



**Green House - China**

Greenhouse with double sloped roof and walls.

## SUNTUF® Plus Standard Profiles

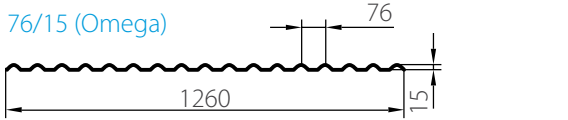
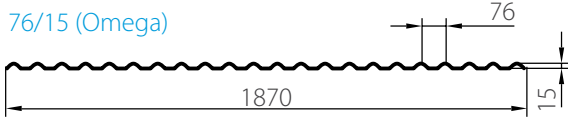
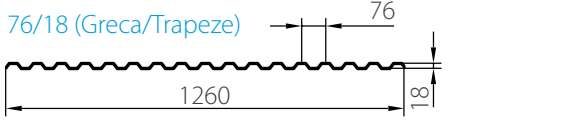
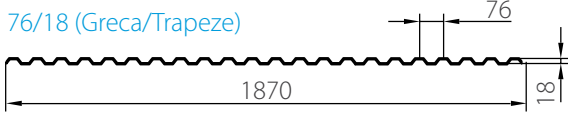
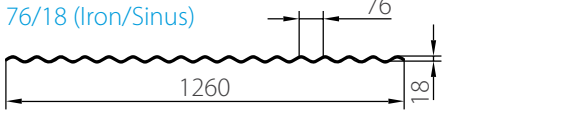
Profile	Thickness mm	Depth mm	Overlap	Trimmed Width	Net Coverage
 <p>76/15 (Omega)</p>	0.8	15	1 Corr.	1260	1210
 <p>76/15 (Omega)</p>	0.8	15	1 Corr.	1870	1820
 <p>76/18 (Greca/Trapeze)</p>	0.8	16	1 Corr.	1260	1210
 <p>76/18 (Greca/Trapeze)</p>	0.8	16	1 Corr.	1870	1820
 <p>76/18 (Iron/Sinus)</p>	0.8	16	1 Corr.	1260	1210

### Custom SUNTUF® Plus Profile for Glass Replacement - Case Study

Since SUNTUF's unique profile matching technology was introduced in 2004, Palram looked for new ways to implement it for the customer's benefit. Two Italian greenhouse owners turned to Palram in search of long term roofing solution after heavy hail storms shattered 5000 sqm of their greenhouses glass glazing panels: Albani E. Ruggieri (located north-west of Rome, project executed in 2007) and De Filippo (located south of Naples, project executed in 2010).

Both customers required a fast, reliable and cost-effective roofing solution that would resist high wind and impact caused by hail and debris. SUNTUF profile matching technology was used to tailor specific corrugation profiles for each project. The sheets were designed to fit preexisting aluminum glazing bars, which resulted in a very simple re-installation for both customers. Technical support for the projects included profile-specific installation guides, project-specific accessories and on-site support.

#### Glass Replacement - Installation Concept

Fitting of the profile made for the Albani E. Ruggieri greenhouse project.

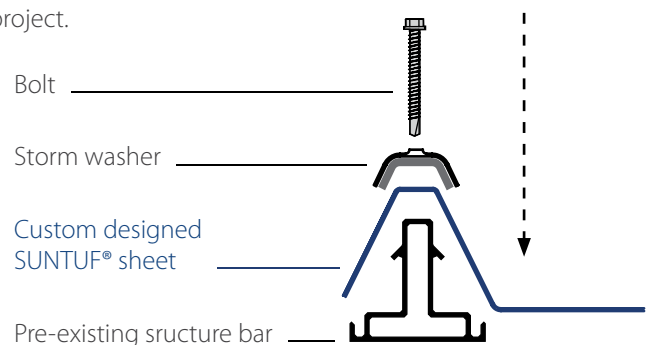





Custom Made SUNTUF Plus for Glass Replacement Project - Southern Italy



## Glass Replacement (Continued)



### Custom Made SUNTUF Plus for Glass Replacement Project - Southern Italy

View from the outside during installation. Upper row still fitted with glass, middle row fitted with custom made SUNTUF Plus panels.



### Custom Made SUNTUF Plus for Glass Replacement Project - Southern Italy

View from the outside after project completion.





Custom Made SUNTUF Plus for Glass Replacement Project - Southern Italy

View from the outside.



Custom Made SUNTUF Plus for Glass Replacement Project - Southern Italy

View from the inside.



**PALRAM H.Q.**

Tel: +972 4 8459900  
Fax: +972 4 8444012  
palram@palram.com  
www.palram.com

**PALRAM EUROPE LTD.**

Tel: +44 1302 380777  
Fax: +44 1302 380778  
sales.europe@palram.com  
www.palram.com

**PALRAM AMERICAS**

Tel: 610 2859918  
Fax: 610 2859928  
palramamericas@palram.com  
www.palramamericas.com



71748 - 08.2015

All marketing materials and any content therewith provided by palram® are provided solely for the purpose of supporting and enhancing the marketing of Palram® products. These materials are protected by Palram's intellectual property rights and may not be used for any other purpose or in connection with the sale of products of any other manufacturer. These materials may not be transferred to or used by any third party without prior permission of Palram.

In as much as Palram Industries has no control over the use to which others may put the material, it does not guarantee that the same results as those described herein will be obtained. Each user of the material should make his own tests to determine the material's suitability for his own particular use. Statements concerning possible or suggested uses of the materials described herein are not to be construed as constituting a license under any Palram Industries patent covering such use or as recommendations for use of such materials in the infringement of any patent. Palram Industries or its distributors cannot be held responsible for any losses incurred through incorrect installation of the material. In accordance with our company policy of continual product development you are advised to check with your local Palram Industries supplier to ensure that you have obtained the most up to date information.

©1997 Palram Industries Ltd. | SUNTUF is a registered trademark of Palram Industries Ltd.

